

ROLLERI

TOOLING LAB

LASER CONSUMABLES
PUNCHING TOOLS - IRON WORKER
SHEAR BLADES
PANEL BENDING TOOLS

BENDING

CLAMPING SYSTEMS
INTERMEDIATES
ADAPTERS





ISO 9001 - ISO 45001
CERTIFIED
COMPANY



Scan the QRCode or click on it and watch the video. You can follow our official Youtube channel www.youtube.com/Rollerispa or watch the video on our web site <https://www.rolleritools.com/media>



Download Rolleri **Bending App**

You will also get our sheet metal unfolding software for free and our bending rule. You can also scan the QR Code of this catalogue by using the app.



Request our bending, punching and ironworker, consumables laser, panel bending tools and shear blades catalogues on www.rolleritools.com/download



The **Bending handbook** target is to supply practice and useful information to reach quickly the required result. A lot of examples, easy formulas and information which explain the proper attitude towards the bending process.



Create your account on www.rolleritools.com You can use Rolleri website to check the delivery time, request quotes, stay update with the news, check prices and place orders directly.



Click on the QR Code near the codes or scan it to check prices and delivery time.



Check the standard sectioning available. Customized sectioning is also available on request. sales@rolleri.it to know more about price and availability.



Download Rolleri **Clamping App**

It contains useful information for all clamping systems, details for the installation and all the user manuals for all those who already have Rolleri systems or who are interested in integrating these with their own press brake.



BENDING TOOLS

R1 TOOLS TYPE

Compatible with press brakes: Accurl, Accurpress, ACL, Adira, Amada, Atlantic, Baykal, BL, Boschert, Boutillon, Bystronic, Beyeler, Euro-B, Coastone, Colgar, Dener, Deratech, Durmazlar, Ermaksan, Farina, Gade, Gasparini, Gecko, Gilardi, Gizelis, Haco, Hindustan, HPM, Iturraspe, Jfy, JMT, LFK, Metfab, MVD, Oriance, Prima Power, Promecam, Rico, Salvagnini, Schiavi, SMD, Sorg, Somo, Vicla, Vimercati, Warcom, Yawei,...

R2-R3 TOOLS TYPE

Compatible with press brakes: Darley, LVD, Safan, Trumpf and press brakes with NSCL system, Bystronic Beyeler RFA, RF, R, S

R4 TOOLS TYPE

Compatible with press brakes: LVD

R5 TOOLS TYPE

Compatible with press brakes: American

R6 TOOLS TYPE

Compatible with press brakes: Hämmerle-Bystronic

R7 TOOLS TYPE

Compatible with press brakes: Colly

R8 TOOLS TYPE

Compatible with press brakes: Colgar

R9 TOOLS TYPE

Compatible with press brakes: Gasparini (axial)

R10 TOOLS TYPE

Compatible with press brakes: Ajial Axial

Rx TOOLS TYPE

Compatible with press brakes: EHT, Ursviken and Weinbrenner

ROLLERI TECH, MODIFICATIONS AND SERVICES

Compatible with all types of press brakes

CLAMPING SYSTEMS, INTERMEDIATES AND ADAPTERS

Compatible with all types of press brakes

ROLLA-V AND SPECIAL DIES

Compatible with all types of press brakes

MARK FREE BENDING AND ACCESSORIES

Compatible with all types of press brakes

PANEL BENDING TOOLS

SHEAR BLADES

PUNCHING TOOLS

R1 TOOLS TYPE

Compatible with punching machines Amada, Amada ABS, Wilson HP, Wilson HP WLS, Mate Ultra Tec

R2 TOOLS TYPE

Compatible with Trumpf punching machines

RS TOOLS TYPE

Compatible with Salvagnini punching machines

SPECIAL TOOLS

Compatible with different types of punching machines

ACCESSORIES

Compatible with different types of punching machines

IRON WORKER

Iron cutting tools

LASER CONSUMABLES

Find out more about our wide range of laser consumables: one of the most complete in the market

6

FAST CLAMPING SYSTEMS

- 8 - ROL200
- 12 - ROL4
- 16 - ROL2
- 18 - WROL
- 22 - WROL2
- 24 - ROL3
- 26 - ROL3/2
- 28 - AROL
- 32 - FAST CLAMP1
- 34 - FAST CLAMP3
- 36 - EASY CLAMP
- 38 - UNIVERSAL FAST CLAMP
- 40 - UNIVERSAL EASY CLAMP
- 42 - ST50-S
- 44 - CROWNING TABLES
- 50 - HEMMING TABLES WITH CROWNING
- 51 - POWER UNITS

52

INTERMEDIATES

- 54 - INTERMEDIATES
- 58 - CLAMPS

60

ADAPTERS

- 62 - UPPER ADAPTERS
- 68 - SCREWED UPPER ADAPTERS
- 72 - LOWER ADAPTERS AND DIE HOLDERS

A		
AD1-A - 63	C 1050-90 - 74	ROL200HYD/KDS EXTREME - 10
AD1-B - 63	C 1050-90/C - 74	ROL200HYD POWER - 10
AD1-C - 63	C 1050/R - 73	ROL200MAN EXTREME - 11
AD1-D - 63	C 1050/R/C - 73	ROL200MAN/KDS EXTREME - 11
AD3 - 63	C 1050/RS - 73	ROL200MAN POWER - 11
AD4 - 57	C 1050/RS/C - 73	ROL200PN EXTREME - 10
AD5 - 74	C 2000/S - 73	ROL200PN/KDS EXTREME - 10
AD6 - 74	C 2500/S - 73	ROL200PN POWER - 10
AD7 - 75	C 3000/S - 73	ROL TA/R1/HYD-PN - 47
AD8-12.7 - 75	C 4000/S - 73	ROL TA/R1/HYD-PN-SPE9 - 50
AD9-12.7 - 75	CTS60 - 73	ROL TA/R1/MN - 47
AD10 - 63	D	ROL TA/R1/MN-SPE9 - 50
AD11 - 64	DOUBLE EASY CLAMP - 37	ROL TA/R2/HYD-PN - 49
AD12 - 64	DOUBLE FAST CLAMP1 - 33	ROL TA/R2/HYD-PN-SPE9 - 50
AD13 - 64	DOUBLE FAST CLAMP3 - 35	ROL TA/R2/MN - 49
AD14 - 64	E	ROL TA/R2/MN-SPE9 - 50
AD15 - 65	EASY CLAMP - 37	ROL TM/R1/HYD-PN - 46
AD16 - 65	F	ROL TM/R1/MN - 46
AD17 - 75	FAST CLAMP1 - 33	ROL TM/R2/HYD-PN - 48, 50
AD18 - 76	FAST CLAMP3 - 35	ROL TM/R2/MN - 48, 50
AD19-A - 65	H	S
AD20 - 65	HPU-E/1 - 10, 14, 21, 31, 51	ST50 - 58
AD20 LVD - 66	HPU-E/2 - 51	ST50R - 58
AD21 - 66	HPU-EXL/1 - 51	ST60 - 58
AD22 - 66	HPU-EXL/2 - 51	ST60R - 58
AD23 - 66	I	STG50 - 58
AD24 - 76	INT35 - 71	STG60 - 58
AD25 - 76	INT35-A - 71	STL50 - 58
AD26 - 76	INT67-79 - 62	STL60 - 58
AD27 - 77	INT80-100 - 62	STL60R - 58
AD28 - 67	INT100 - 54	STLG60 - 58
AD29 - 67	INT100-A - 56	STX60 - 58
ADX - 67	INT100-AAM1 - 57	STX60R - 58
ADX2 - 67	INT100-AAM2 - 57	STXG60 - 58
AROLHYD EXTREME - 31	INT100-AAM3 - 57	T
AROLHYD POWER - 31	INT100-A AMERICAN - 57	TC 2000/S - 74
AROLHYD SUPREME - 31	INT100F - 54	TC 2500/S - 74
AROLPN EXTREME - 30	INT100-N NEWTON - 63	TC 3000/S - 74
AROLPN POWER - 30	INT120 - 54	TC 4000/S - 74
AROLPN SUPREME - 30	INT120-40 - 54	W
AW1-A - 68	INT120-40-A - 57	WROLHYD EXTREME - 21
AW1-B - 68	INT120-40 HD - 56	WROLHYD POWER - 21
AW1-C - 68	INT120-A - 56	WROLHYD SUPREME - 21
AW1-D - 68	INT120 F - 54	WROLPN EXTREME - 20
AW3 - 69	INT120 HD - 55	WROLPN POWER - 20
AW4 - 71	INT150 - 54	WROLPN SUPREME - 20
AW10 - 69	INT150-40 - 55	
AW11 - 69	INT150-40 HD - 56	
AW12 - 69	INT150 HD - 55	
AW13 - 70	P	
AW14 - 70	PDU 2 MOLT - 51	
AW15 - 70	PDU MOLT - 10, 20, 30, 51	
AWC13.5 - 71	R	
AWC16 - 70	ROL4 - 12	
AWX - 71	ROL4HYD - 14	
C	ROL4MAN - 15	
	ROL200HYD EXTREME - 10	

FAST CLAMPING SYSTEMS



TIME SAVING

Rolleri fast clamping systems are designed to improve operator's work during machine setup.



CLAMPING APP

Rolleri app contains not only very useful information but also updated users manuals of Rolleri fast clamping systems.



SAFETY

Rolleri fast clamping systems comply with the European Regulations currently in force, i.e. MACHINE DIRECTIVE 2006/42/CE .

TREME

R1 PUNCHES

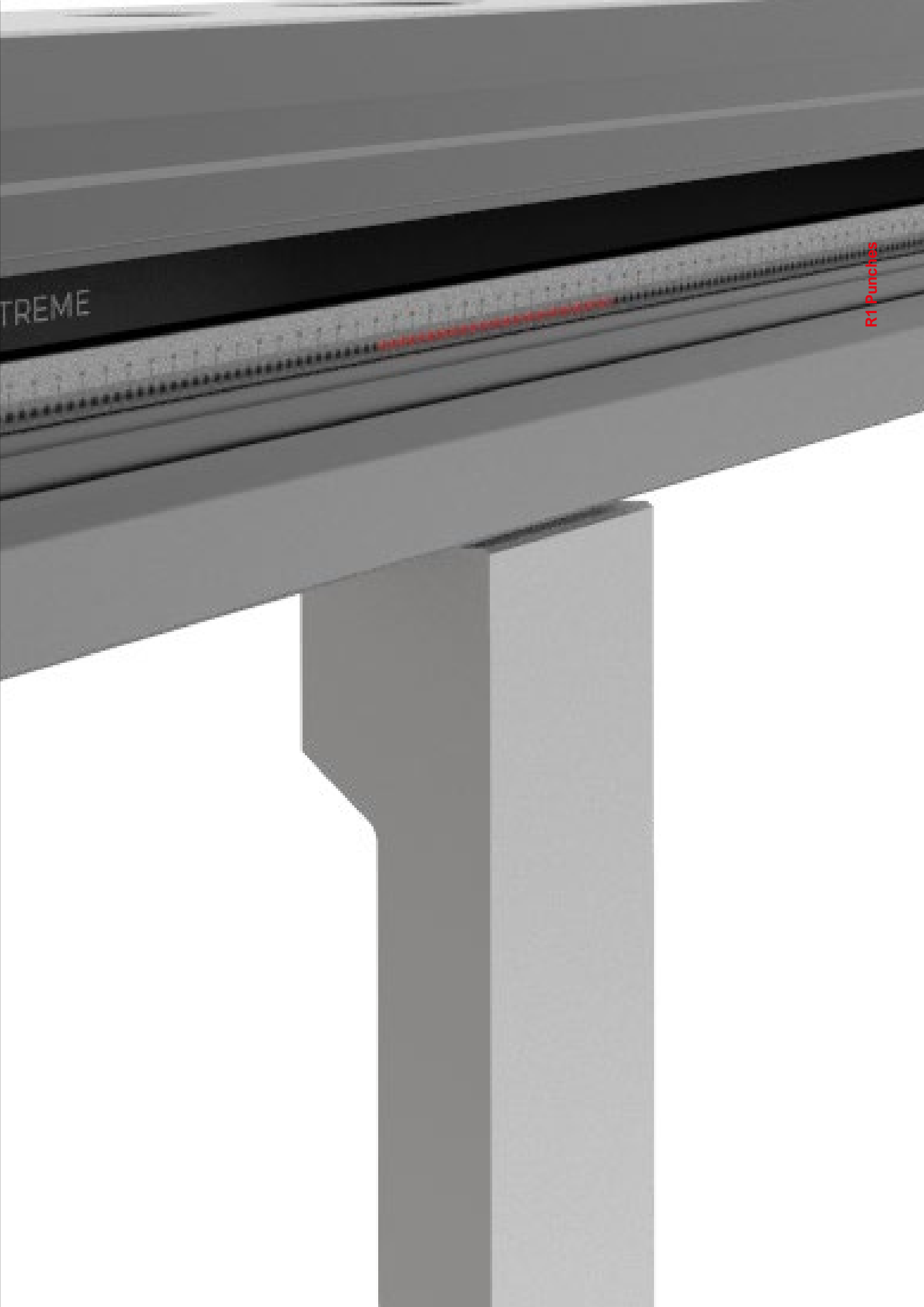

ROL200 is Rolleri patented system for vertical and safe insertion and removal of all punches with R1 type tang.

The Extreme version can be supplied with all standard intermediates (H100, H120, H132, H150) with 7mm bending axis (Z1) and with 20mm bending axis (Z2), whereas the Power version has been designed to supply one single fast clamping system for both pneumatic and hydraulic systems. In fact, all components and pipes have been standardized so that ROL200 Power can open and close clamps pneumatically or hydraulically.

ROL200 Power represents an easy, safe and convenient solution to meet any need, as it is suitable to equip new press brakes as well as to retrofit already operating press brakes.



TOOL INSERTION AND REMOVAL

Punches are inserted and removed with a special movement, which avoids any accidental fall and improves punch insertion.



UPPER CLAMPING



ROL200 KDS is compatible with all press brakes with Amada-Promecam type tang. No punch modification is required.

DOUBLE CLAMPING



The new ROL200KDS combines convenience, reliability and safety of ROL200 with versatility given by a back clamp and it guarantees the maximum use flexibility.

TOOL CHANGE



A front clamp enables fast vertical tool insertion. Back clamp enables horizontal tool insertion.

ALIGNMENT



These fast clamping systems seat and clamps punches automatically.

SAFETY



Antifall system "full safety" for all R1 punches without any tooling modification.

SUPPLY



The system is available in pneumatic, hydraulic and manual version. ROL200 Power can work hydraulically and pneumatically without any component change.

INSTALLATION



Installation is easy and quick as the system is supplied with Rolleri standard intermediates. No modifications of the press brake are required.

COMPATIBILITY

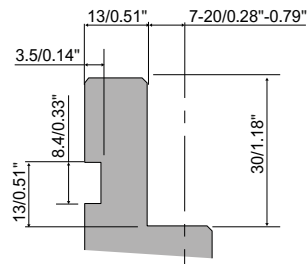

TECHNICAL INFORMATION

Length	150 mm 5.90"
Max. press force	1000 Kn/m
Antifall system	●
Pneumatic version	●
Hydraulic version	●
Manual version	●
Back clamp	○

● = standard ○ = available for some models



Scan the QRCode or click on it and watch the video to discover more about this system



Download Rolleri Clamping App

It contains useful information for all clamping systems, details for the installation and all the user manuals for all those who already have Rolleri systems or who are interested in integrating these with their own press brake.

PNEUMATIC			BAR 12
INTERMEDIATES	Extreme	Extreme+KDS	Power
<u>INT100F</u>	•	•	-
<u>INT120F</u>	•	•	-
<u>INT100</u>	•	•	•
<u>INT120</u>	•	•	-
<u>INT150</u>	•	•	-
<u>INT120-40</u>	•	•	-
<u>INT150-40</u>	•	•	-
<u>INT120HD</u>	•	-	-
<u>INT150HD</u>	•	-	-
<u>INT120-40HD</u>	•	-	-
<u>INT150-40HD</u>	•	-	-



Driving unit: PDU MOLT

- Checks air pressure at system inlet and outlet
- Amplifies compressed air for better clamping
- Gives an electric signal to CNC in case of low pressure and activates alarm stop
- All intermediates are connected to each other by means of pneumatic pipes. To guarantee high clamping force, the system needs 12bar or 16 bar according to the model
- Supplied with pressure multiplier
- Available in TOP version in a protective cabinet

HYDRAULIC			BAR 20
INTERMEDIATES	Extreme	Extreme+KDS	Power
<u>INT100F</u>	•	-	-
<u>INT120F</u>	•	•	-
<u>INT100</u>	•	-	•
<u>INT120</u>	•	•	-
<u>INT150</u>	•	•	-
<u>INT120-40</u>	•	•	-
<u>INT150-40</u>	•	•	-
<u>INT120HD</u>	•	-	-
<u>INT150HD</u>	•	-	-
<u>INT120-40HD</u>	•	-	-
<u>INT150-40HD</u>	•	-	-



DRIVING UNIT: HPU-E/1

- To be connected to press brake CNC for opening and closing
- Gives an electric signal to CNC in case of low pressure and activates alarm stop
- Two driving units available: one can operating with 220-380V and one operating with 110V
- Operating pressure: 30/80/160 bar



Scan the QRCode or click on it and watch the video to discover more about this system



Find out more about this clamping system by scanning the QR code or clicking on it.

Create your account on www.rolleritools.com



MANUAL

INTERMEDIATES	Extreme	Extreme+KDS	Power
INT100F	-	•	-
INT120F	-	•	-
INT100	-	•	-
INT120	-	•	-
INT150	-	•	-
INT120-40	-	•	-
INT150-40	-	•	-
INT120HD	•	-	-
INT150HD	•	-	-
INT120-40HD	•	-	-
INT150-40HD	•	-	-

ROL200 manual is very easy to be used thanks to a central screw with controlled lead to clamp punches promptly and safely. Intermediates don't need any connection to other devices, hence its very quick installation.

ROL200 manual is available with back clamp to insert punches on the back of an intermediate to bend complicated profiles.

Fast clamping systems



ROL200 EXTREME



ROL200 POWER



Scan the QRCode or click on it and watch the video to discover more about this system.



Find out more about this clamping system by scanning the QR code or clicking on it.

Create your account on www.rolleritools.com

ROL4 is a fast clamping system with a very powerful clamping force, which makes it suitable to seat and clamp heavy tools. ROL4 is available in manual and hydraulic version. It's always supplied with a back clamp to insert punches on the back of an intermediate.

The front cover makes the system good-looking and protects the pipes between intermediates. Such protection avoids any accidental collision and preserves all components. The main features of ROL4 are: reliability, robustness and safety.

Thanks to a crowning wedge, ROL4 can compensate structure deflection of a press brake. In the central oblong hole you can loose the screw to release the wedge and move it left and right to adjust intermediate height.



UPPER SYSTEM



ROL4 is compatible with all press brakes with Amada-Promecam type tang. No punch modification is required.

DOUBLE CLAMPING



The double clamping system guarantees the maximum use flexibility.

TOOL CHANGE



Front and back clamps enable horizontal tool change.

ALIGNMENT



These fast clamping systems seat and clamps punches automatically (only front clamp).

SAFETY



Antifall system "full safety" for all R1 punches without any tooling modification.

SUPPLY



This system is available in hydraulic and manual version.

INSTALLATION



Installation is easy and quick as the system is supplied with Rolleri standard intermediates. No press brake modifications are required.

COMPATIBILITY

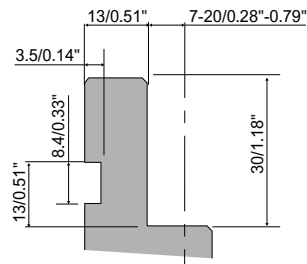

Length	150 mm 5.90"
Max. press force	1000 Kn/m
Antifall system	●
Pneumatic version	-
Hydraulic version	●
Manual version	●
Back clamp	●

● = standard ○ = available for some models



Scan the QRCode or click on it and watch the video to discover more about this system



Download Roller Clamping App

It contains useful information for all clamping systems, details for the installation and all the user manuals for all those who already have Roller systems or who are interested in integrating these with their own press brake.

HYDRAULIC

BAR 160

INTERMEDIATES

<u>INT100F</u>	•
<u>INT120F</u>	•
<u>INT100</u>	•
<u>INT120</u>	•
<u>INT150</u>	•
<u>INT120-40</u>	-
<u>INT150-40</u>	•
<u>INT120HD</u>	•
<u>INT150HD</u>	•
<u>INT120-40HD</u>	•
<u>INT150-40HD</u>	•



Driving Unit: HPU-E/1

- To be connected to press brake CNC for opening and closing
- Gives an electric signal to CNC in case of low pressure and activates alarm stop
- It works with 220-380V
- Operating pressure: 30/80/160 bar



Scan the QRCode or click on it and watch the video to discover more about this system



Find out more about this clamping system by scanning the QR code or clicking on it.

Create your account on www.rolleritools.com

**MANUAL**

INTERMEDIATES

<u>INT100F</u>	•
<u>INT120F</u>	•
<u>INT100</u>	•
<u>INT120</u>	•
<u>INT150</u>	•
<u>INT120-40</u>	•
<u>INT150-40</u>	•
<u>INT120HD</u>	•
<u>INT150HD</u>	•
<u>INT120-40HD</u>	•
<u>INT150-40HD</u>	•



Scan the QRCode or click on it and watch the video to discover more about this system.



Find out more about this clamping system by scanning the QR code or clicking on it.
Create your account on www.rolleritools.com

ROL2 is the best system to clamp R1 type dies with 60mm 2.36" and 90mm 3.54" base.

Thanks to its construction, when the clamp is closed, clamping pressure is evenly distributed along the die and guarantees its perfect alignment. The main advantage of such system consists in die V opening being automatically centered. In addition to this, tooling clamping is faster than ever. Both in case an operator uses a pneumatic, hydraulic or manual version, he can start bending after a few seconds under the safest conditions.

ROL2 has been designed to complete clamping system range for R1 type tools.

This system can be mounted in brand new press brakes as well as in already operating press brakes. ROL2 means speed, quality and flexibility.



The new design enables clamping of the smallest die segments



Available with CTS holder to increase system height





LOWER SYSTEM

ROL2 system is compatible with all press brakes with Amada-Promecam tang. No tool modification is required.

SPECIAL POLYURETHANE INSERT

ROL2 system contains a device which activates ROL2 CLAMP1 clamps. These clamps are integrated in the system and can clamp and release dies. A special polyurethane insert mounted in the clamps guarantees the perfect die alignment.

Clamping force is also evenly distributed along the tools.



SUPPLY

This system is available in manual, pneumatic and hydraulic versions. The manual system is composed of a special clamp called ROL2 CLAMP1, which is activated by a lever which you have to insert in the middle of the clamp. The pneumatic system is composed of pneumatic clamps L=150mm which are activated by a pneumatic driving unit or by press brake CNC.



INSTALLATION ON TABLES 60mm AND 90mm WIDE

Clamps can be installed directly to press brake table using the holes for standard clamps (hole pitch 100mm). In alternative you need to modify the hole pitch.

In order to clamp Rolleri R1 dies with 60mm 2.36" base in tables 90mm 3.54" wide, we supply 2 shims 15mm 0.59" wide (with clamping pins).

The system is compatible with press brakes with automatic crowning systems.



INSTALLATION

ROL2 system is easy, innovative and, above all, flexible. To be mounted in a new press brake, it only needs a specific hole pitch and you can mount clamps directly to the table.

To be mounted in an already operating press brakes, the system is supplied with a die holder.



COMPATIBILITY

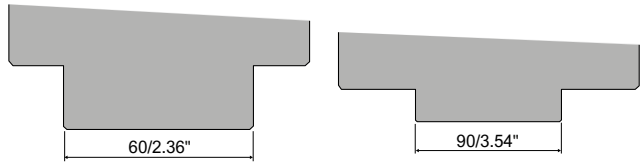

TECHNICAL INFORMATION

Length	Manual and hydraulic: 500mm 19.68" Pneumatic: 150mm 5.90"
Pneumatic version	<input checked="" type="radio"/>
Hydraulic version	<input checked="" type="radio"/>
Manual version	<input checked="" type="radio"/>
Incremento altezza del banco	<input type="radio"/>

● = standard ○ = on request



Scan the QRCode or click on it and watch the video to discover more about this system



R1 dies are required for ROL2 system. Click on the QR Code or scan it to check the standard tools available.

WROL clamping systems represent an evolution of R2 New Standard. They look like long beams in one solid piece with a new structural and aesthetic design. Every WROL undergoes heating treatment to give proper hardness to the contact surfaces of the system with tooling. According to the necessary capacity you can choose among Power, Supreme and Extreme line. Several lengths are available from 1100mm (3.608 ft) to 6100mm (20.131 ft) for any press brake. You can also retrofit a press brake with R1 type tang to R2 New Standard and gain some daylight thanks to the limited working height of WROL being only 80mm 3.15".

In this version you can choose between AWP version (fix) and AWPC with crowning wedges.

The appearance has been improved by reducing the overall dimensions with ergonomic advantages too and by mounting LED bars for the tool positioning or for on/off signal.

W ROL EXTREME
with LED bar for tool
positioning

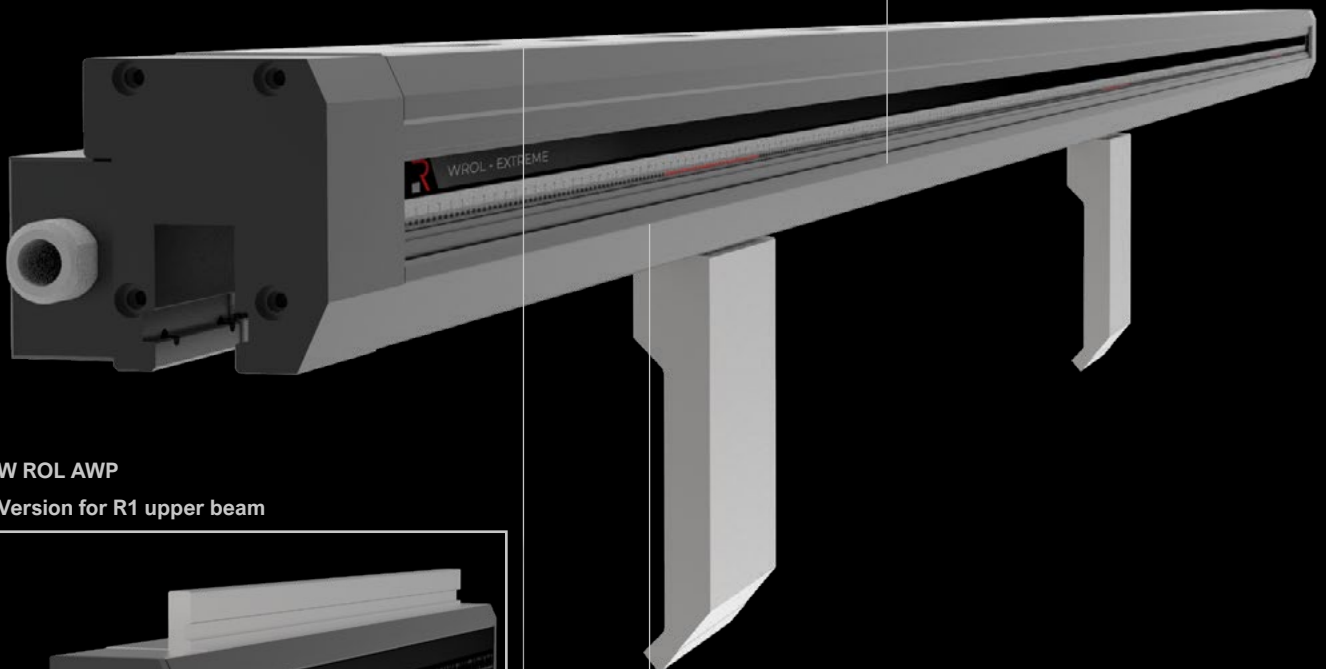

W ROL AWP
Version for R1 upper beam

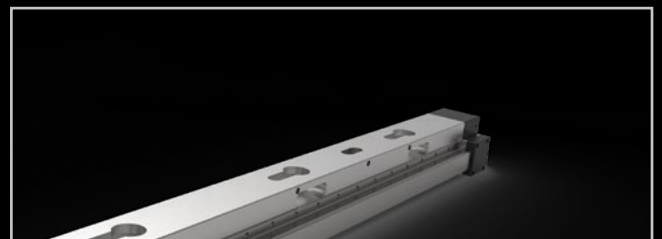
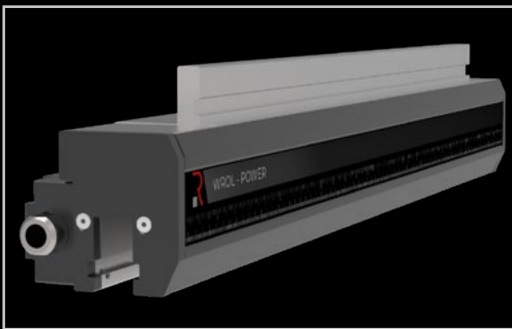

TX



Rolleri adjustment system during installation is very useful to adjust the overall beam length. The subsequent advantage is the correct position of the bending axis in relation to the backgauges. Thanks to this, precision and repeatability are guaranteed for any profile.

UPPER SYSTEM



WROL clamping systems are for R2 New Standard tools. They can also be used to retrofit a R1 type press brake to clamp R2 New Standard tooling.

TOOL



WROL clamping system guarantees the maximum flexibility, as punches can be mounted backward.

TOOL CHANGE



Punches with ROL1 or with Quick Lock system can be inserted vertically, whereas punches with safety pins can be slided in horizontally.

ALIGNMENT



All WROL systems seat punches automatically both if they have head thrust and shoulder thrust.

SAFETY



Equipped with the antifall system "full safety" for all R2 and R4 (W series) tooling with Quick Lock or with safety pins.

LED BAR



The system can be equipped with a led bar for the correct tool positioning (WROL Exteme) or to indicate if the system is on or off (WROL Supreme).

SUPPLY



The system is available in pneumatic and hydraulic versions.

INSTALLATION



WROL systems can be mounted to the upper beam thanks to holes with standard pitch. TX enables any correction along the X axis. AWP and AWPC models can be easily mounted without any modification of the upper beam.

Instructions to connect the system with press brake CNC are given in the user manual.

COMPATIBILITY

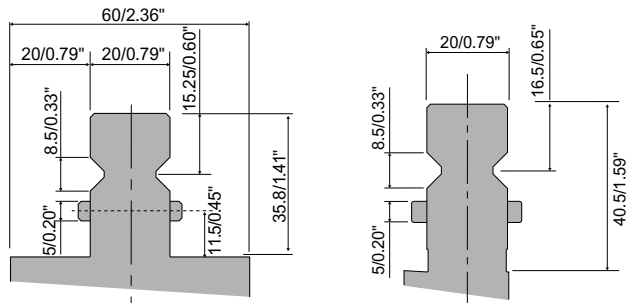

TECHNICAL INFORMATION

Length	from 1100 mm 43.31" to 6100 mm 240.15"
Max. press force	○
Antifall system	●
Pneumatic version	●
Hydraulic version	●
Manual version	-
LED Indicator	○

● = standard ○ = available for some models



Download Roller Clamping App

It contains useful information for all clamping systems, details for the installation and all the user manuals for all those who already have Roller systems or who are interested in integrating these with their own press brake.



Scan the QRCode or click on it and watch the video to discover more about this system



Find out more about this clamping system by scanning the QR code or clicking on it.

Create your account on www.rolleritools.com

PNEUMATIC

	Power	Supreme	Extreme
Air supply	12 bar/175 psi	12 bar/175 psi	12 bar/175 psi
Material	Hardened C45 steel	Hardened 42CrMo4 steel	Hardened 42CrMo4 steel
Max. press force on the head	1800 kN/m 60 t/ft	1800 kN/m 60 t/ft	1800 kN/m 60 t/ft
Max. press force on the shoulders	1800 kN/m 60 t/ft	2500 kN/m 85 t/ft	2500 kN/m 85 t/ft
LED on/off	○	●	○
LED for tool positioning	○	○	●



Driving unit: PDU MOLT

- Checks air pressure at system inlet and outlet
- Amplifies compressed air for better clamping
- Gives an electric signal to CNC in case of low pressure and activates alarm stop
- Working are pressure: 12bar
- Supplied with pressure multiplier
- Available in TOP version in a protective cabinet

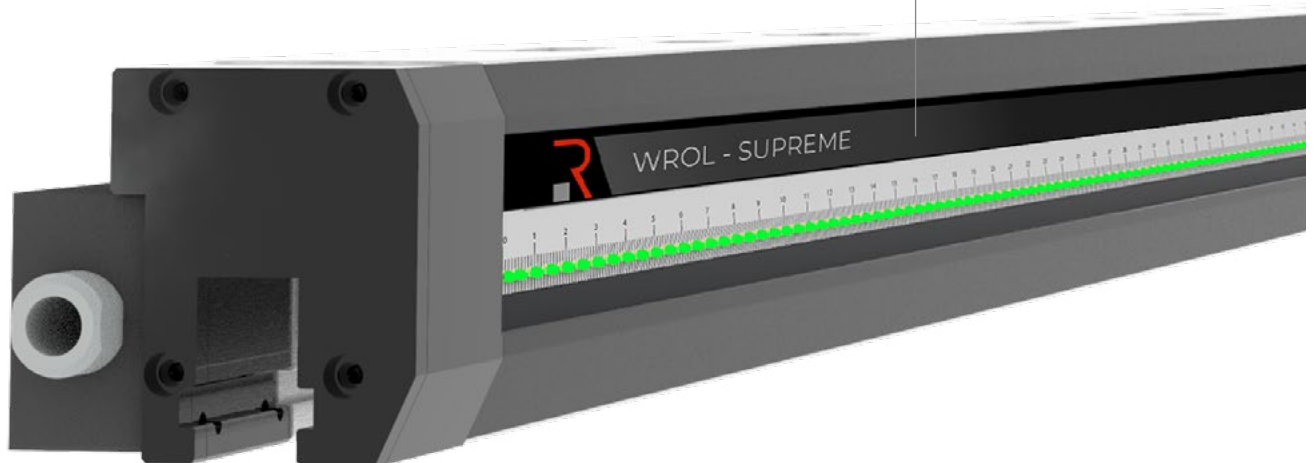

R2 punches are required for WROL system.
Click on the QR Code or scan it to check the standard tools available.



Find out more about this clamping system by scanning the QR code or clicking on it.
Create your account on www.rolleritools.com

HYDRAULIC

	Power	Supreme	Extreme
Air supply	30 bar/435 psi	30 bar/435 psi	30 bar/435 psi
Material	Hardened C45 steel	Hardened 42CrMo4 steel	Hardened 42CrMo4 steel
Max. press force on the head	1800 kN/m 60 t/ft	1800 kN/m 60 t/ft	1800 kN/m 60 t/ft
Max. press force on the shoulders	1800 kN/m 60 t/ft	2500 kN/m (85 t/ft)	2500 kN/m 85 t/ft
LED on/off	<input type="radio"/>	<input checked="" type="radio"/>	<input type="radio"/>
LED for tool positioning	<input type="radio"/>	<input type="radio"/>	<input checked="" type="radio"/>



Driving unit: HPU-E/1

- To be connected to press brake CNC for opening and closing
- Gives an electric signal to CNC in case of low pressure and activates alarm stop
- Working power 220-380V
- Operating pressure: 30/80/160 bar

W ROL POWER
without LED for tool
positioning

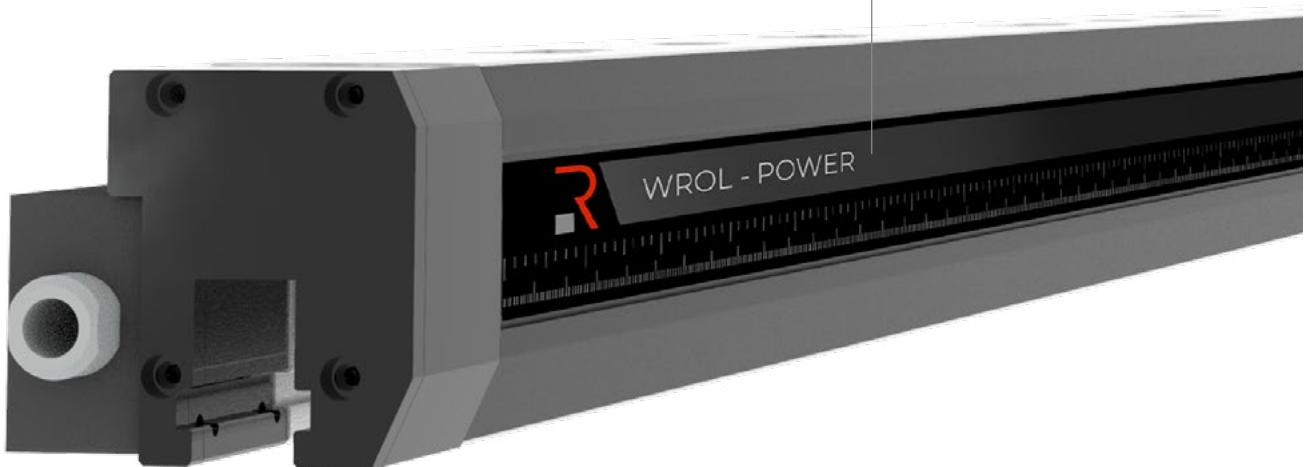

Request our bending, punching and ironworker, consumables laser, panel bending tools and shear blades catalogues on www.rolleritools.com/download



Find out more about this clamping system by scanning the QR code or clicking on it.
Create your account on www.rolleritools.com

WROL2 clamping systems represent an evolution of New Standard systems for R2, R3 dies and R4 dies with 12.7mm 0.5" tang. They are made in one solid piece with a new structural and aesthetic design. Every WROL undergoes heating treatment to give the proper hardness to the contact surfaces with tooling. According to the necessary capacity you can choose among Power, Supreme and Extreme line. Several lengths are available from 1100mm (3.608 ft) to 6100mm (20.131 ft) for any press brake. WROL2 installation along the axis is guaranteed by TX adjustment.

A press brake can be retrofitted from R1 to R2 New Standard without losing too much daylight thanks to the limited height of ROL2.

The appearance has been improved by reducing the overall dimensions with ergonomic advantages too.



TX

Rolleri adjustment system during installation is very useful to adjust the overall table length.

The subsequent advantage is correct position of the bending axis in relation to backgauges. Thanks to this, precision and repeatability are guaranteed for any profile.





LOWER SYSTEM

WROL2 clamping systems are for R2 New Standard, R3 dies and R4 dies with 12.7mm 0.5" tang.



SUPPLY

The system is available in pneumatic and hydraulic versions.



INSTALLATION

WROL2 systems can be mounted onto a lower beam thanks to holes with standard pitch. TX enables any correction along the X axis.

Instructions to connect the system to press brake CNC are given in the user manual.

COMPATIBILITY

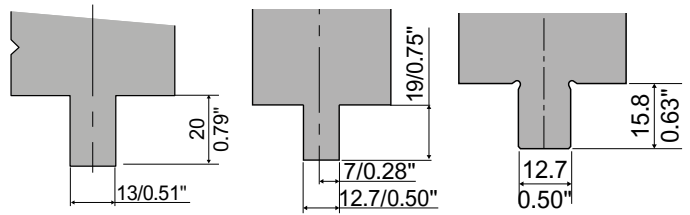

TECHNICAL INFORMATION

Material	Hardened C45 steel
Length	from 1100 mm 43.31" to 6100 mm 240.15"
Height	70 mm 2.76"
Max.press force	2000 kN/m
Pneumatic version	● 12 bar/175 psi
Hydraulic version	●
Manual version	-

● = standard



R2-R3 dies are required for WROL/2 system. Click on the QR Code or scan it to check the standard tools available.



Find out more about this clamping system by scanning the QR code or clicking on it.
Create your account on www.rolleritools.com

ROL3 clamping systems represent the widest range for any type of press brake.

They are complete systems with clamps and beam and they can be pneumatic or hydraulic. Dimensions and length are tailor made according to the press brake upper beam. ROL3 is suitable for heavy duty jobs and for high tonnage, like 5000kN/m up to 10000 kN/m.

The material used for main frame and all components are FEM calculated to guarantee safety.

This solution is quick, handy and convenient.

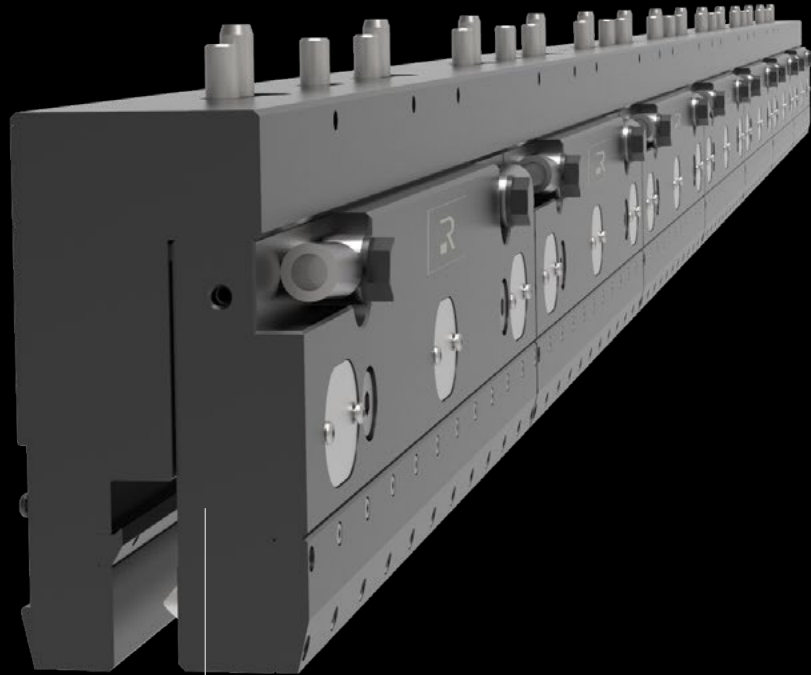

For some applications single clamps have to be mounted directly to a press brake upper beam. Rolleri can produce a fast clamping system consisting of clamps only to avoid any upper beam modification.

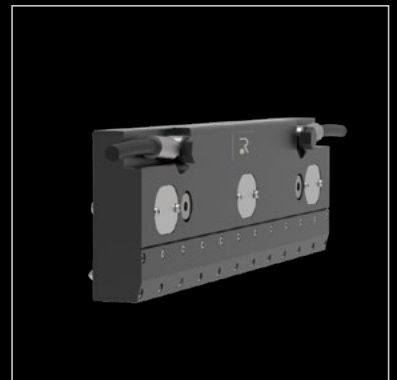

UPPER SYSTEM



ROL3 clamping system can be produced for LVD, Bystronic Beyeler RFA-RF-R-S, Colly, Colgar, Ajial-Axial, EHT and Ursviken press brakes.

TOOL CHANGE



Punches type R3 RFA, RF and R can be inserted vertically, whereas punches type R3 S, R4 and R5 can be slided in horizontally.

ALIGNMENT



Most R3 clamping systems can lift and seat punches automatically.

SUPPLY



The system is available in hydraulic and pneumatic versions.

INSTALLATION



ROL3 systems can be mounted to an upper beam with holes and screws. During the design phase, Rolleri technicians prepare a product drawing.

In order to mount only clamps directly to an upper beam, the original hole pitch is used.

Instructions to connect the system to press brake CNC are given in the user manual.

TECHNICAL INFORMATION

Material	C45 - 42CrMo4
Length	from 500 mm 19.68"
Antifall system	●
Pneumatic version	●
Hydraulic version	●
Manual version	●

COMPATIBILITY

Vertical tool change

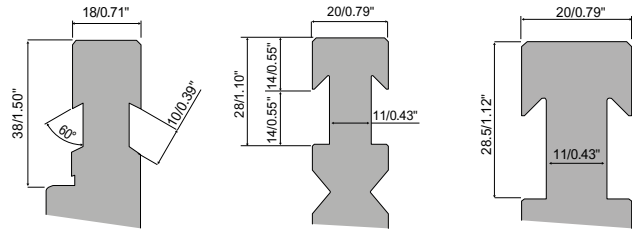

Horizontal tool change

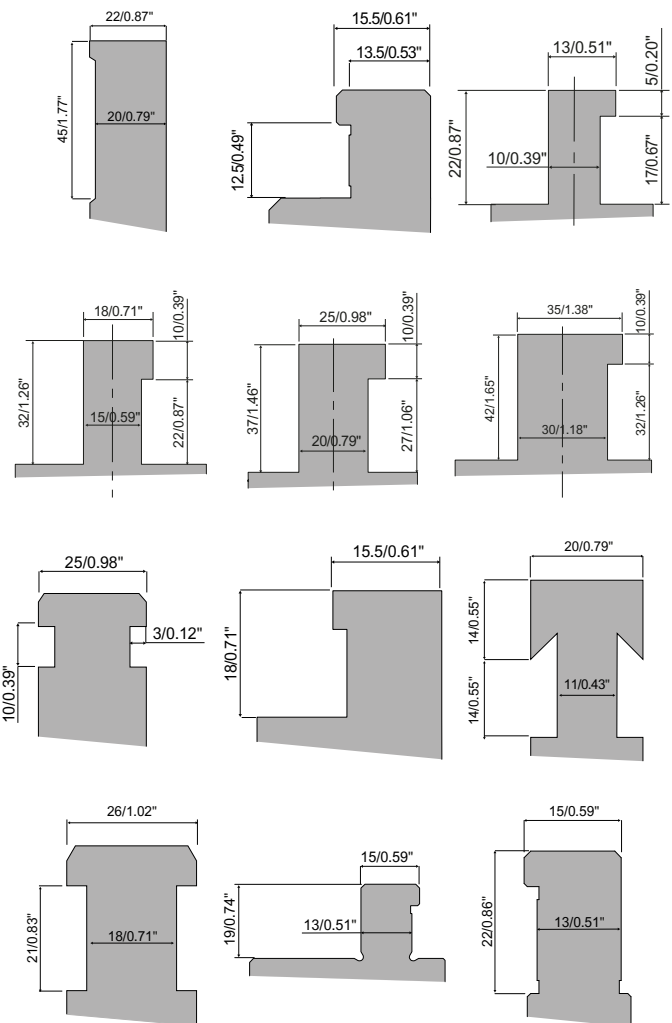

Download Roller Clamping App.

It contains useful information for all clamping systems, details for the installation and all the user manuals for all those who already have Rolleri systems or who are interested in integrating these with their own press brake.



Find out more about this clamping system by scanning the QR code or clicking on it.

Create your account on www.rolleritools.com

ROL3/2 lower clamping systems are an evolution of clamping systems for Colly, EHT, Weinbrenner and other standard dies. They are made in one solid piece with a new structural and aesthetic design. Every ROL3/2 undergoes heating treatment to give proper hardness to the contact surfaces with tooling. Several lengths are available from 1100mm (3.608 ft) to 6100mm (20.131 ft) for any press brake. ROL3/2 installation along the axis is guaranteed by TX adjustment.

The appearance has been improved by reducing the overall dimensions with ergonomic advantages too.



LOWER SYSTEM



ROL3/2 lower clamping systems are for Colly, Axial, EHT and Weinbrenner dies and heavy duty Promecam applications with base 60mm and 90mm.

SUPPLY



The system is available in pneumatic and hydraulic versions.

INSTALLATION



ROL3/2 systems can be mounted onto a press brake table with holes and screws. During the design phase, Rolleri technicians prepare a product drawing. In order to mount only clamps directly to a table, the original hole pitch is used. Instructions to connect the system to press brake CNC are given in the user manual.

COMPATIBILITY

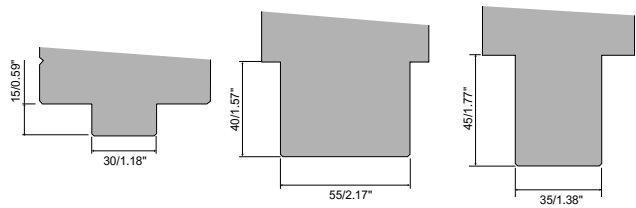

TECHNICAL INFORMATION

Material	C45 - 42CrMo4
Length	from 1100 mm 3.608 ft to 6100 mm 20.131 ft
Height	from 80 mm 3.15"
Max.press force	300 kN/m
Pneumatic version	● 12 bar/175 psi
Hydraulic version	●
Manual version	-



Download Rolleri **Clamping App**. It contains useful information for all clamping systems, details for the installation and all the user manuals for all those who already have Rolleri systems or who are interested in integrating these with their own press brake.



Find out more about this clamping system by scanning the QR code or clicking on it. Create your account on www.rolleritools.com

AROL systems represent an evolution of American clamping systems. They look like long beams in one solid piece with a new structural and aesthetic design. Every AROL undergoes heating treatment to give proper hardness to the contact surfaces of the system with tooling. According to the necessary capacity you can choose among Power, Supreme and Extreme line. Several lengths are available from 1100mm (3.608 ft) to 6100mm (20.131 ft) for any press brake. You can also retrofit a press brake with R1 type tang to clamp American type tools and gain some daylight

thanks to the limited working height of AROL being only 80mm 3.15". In this version you can choose between AWP version (fix) and AWPC with crowning wedges.

The appearance has been improved by reducing the overall dimensions with ergonomic advantages too and by mounting LED bars for the tool positioning or for on/off signal.



TX



Rolleri adjustment system during installation is very useful to adjust the overall beam length.

The subsequent advantage is the correct position of bending axis in relation to backgauges. Thanks to this, precision and repeatability are guaranteed for any profile.

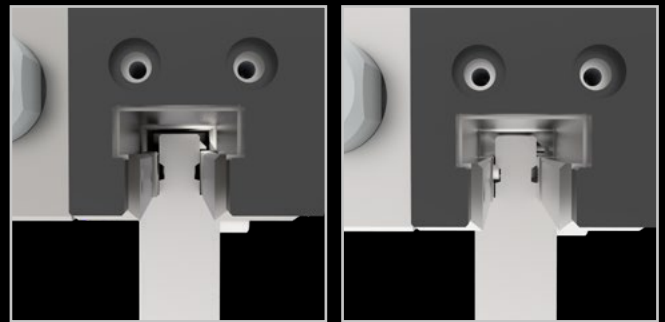

**UPPER SYSTEM**

AROL clamping systems are for American style tooling.

**TOOL**

AROL clamping system guarantees the maximum flexibility, as punches can be mounted backward.

**TOOL CHANGE**

Punches with Quick Lock system can be inserted vertically, whereas punches with safety groove can be slid in horizontally.

**ALIGNMENT**

AROL systems guarantee perfect alignment along X axis.

Punches with Quick Lock are lifted and seated automatically on the shoulders.

**SAFETY**

AROL guarantees maximum safety for all punches with Quick Lock and with antifall groove. To clamp punches with straight tang (without Quick Lock or safety groove), we recommend to slide them horizontally using dies as support.

**LED BARS**

The system can be equipped with a led bar for the correct tool positioning (AROL Extrem) or to indicate if the system is on or off (AROL Supreme).

**SUPPLY**

The system is available in pneumatic and hydraulic versions.

**INSTALLATION**

AROL systems can be mounted to an upper beam thanks to holes with standard pitch. TX enables any correction along the X axis.

Instructions to connect the system to press brake CNC are given in the user manual.



Scan the QRCode or click on it and watch the video to discover more about this system



Find out more about this clamping system by scanning the QR code or clicking on it.

Create your account on www.rolleritools.com

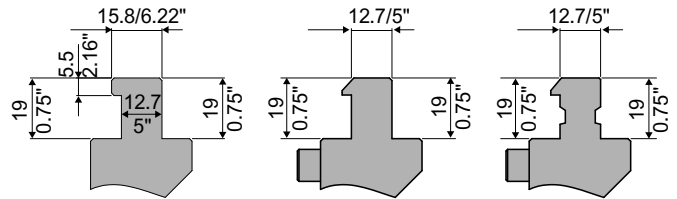
COMPATIBILITY**TECHNICAL INFORMATION**

Length	from 1100 mm 43.31" to 6100 mm 240.15"
Max.press force	○
Antifall system	●
Pneumatic version	●
Hydraulic version	●
Manual version	-
LED Indicator	○

● = standard ○ = available for some models

PNEUMATIC

	Power	Supreme	Extreme
Air supply	12 bar/175 psi	12 bar/175 psi	12 bar/175 psi
Material	Hardened C45 steel	Hardened 42CrMo4 steel	Hardened 42CrMo4 steel
Max. press force on the head	60 t/ft 1800 kN/m	60 t/ft 1800 kN/m	60 t/ft 1800 kN/m
Max. press force on the shoulders	60 t/ft 1800 kN/m	85 t/ft 2500 kN/m	85 t/ft 2500 kN/m
LED on/off	○	●	○
LED for tool positioning	○	○	●



Driving unit: PDU MOLT

- Checks air pressure at system inlet and outlet
- Amplifies compressed air for better clamping
- Gives an electric signal to CNC in case of low pressure and activates alarm stop
- Working are pressure: 12bar
- Supplied with pressure multiplier
- Available in TOP version in a protective cabinet



R5 punches are required for AROL system. Click on the QR Code or scan it to check the standard tools available.



Find out more about AROL SUPREME by scanning the QR code or clicking on it.
Create your account on www.rolleritools.com

HYDRAULIC

	Power	Supreme	Extreme
Air supply	30 bar/435 psi	30 bar/435 psi	30 bar/435 psi
Material	Hardened C45 steel	Hardened 42CrMo4 steel	Hardened 42CrMo4 steel
Max. press force on the head	60 t/ft 1800 kN/m	60 t/ft 1800 kN/m	60 t/ft 1800 kN/m
Max. press force on the shoulders	60 t/ft 1800 kN/m	85 t/ft 2500 kN/m	85 t/ft 2500 kN/m
LED on/off	○	●	○
LED for tool positioning	○	○	●



Driving unit: HPU-E/1

- To be connected to press brake CNC for opening and closing
- Gives an electric signal to CNC in case of low pressure and activates alarm stop
- Working power 220-380V
- Operating pressure: 30/80/160 bar



Request our bending, punching and ironworker, consumables laser, panel bending tools and shear blades catalogues on www.rolleritools.com/download



Find out more about AROL EXTREME by scanning the QR code or clicking on it.
Create your account on www.rolleritools.com

FAST CLAMP1 is a combination of traditional clamps with screws and with a lever. Clamps are made of a more resistant material and undergo several treatments to increase their resistance and to avoid corrosion. Clamps are opened and closed by means of a lever rotating around a central pin. One of the main features of FAST CLAMP1 is the adjustability of the pin. Thanks to this feature, we can always control the clamping force of punches, even in case punch tang is worn out.

FAST CLAMP1 can be mounted on all standard intermediates and thanks to a hardened back plate, the pin doesn't damage the

intermediate as it happens in traditional clamps.

A removable lever extender can be used in order to open and close clamps easier. Such lever extender can be used to open clamps with LC shorter lever mounted on the right edge of the upper beam to avoid collision during box bending.

With FAST CLAMP1 R1 punches with ROL1 ball bearings can be inserted vertically, lifted and seated automatically.

To be used with ROL1 system, punches are modified and equipped with ball bearings





UPPER SYSTEM



FAST CLAMP1 is compatible with all press brakes with Amada-Promecam tang.

To be used with ROL1 system, punches are modified and equipped with ball bearings.

DOUBLE CLAMPING



FAST CLAMP1 is available with front clamp only and with double clamps (front and back) - DOUBLE FAST CLAMP1.



TOOL CHANGE

Both front and back clamps enable vertical tool change.



ALIGNMENT

FAST CLAMP1 lifts and seats punches automatically and guarantees their perfect alignment.



SAFETY

Vertical tool change is enabled by ball bearings which also work as antifall system.



SUPPLY

The system is available in manual version. It's a complete, manual, fast and convenient clamping system.



INSTALLATION

FAST CLAMP1 is designed for a press brake with 50mm distance between intermediates. In case such distance is bigger, please make sure that the minimum quantity of ball bearings is taken by the clamp. Such quantity depends on the tool type and length.

COMPATIBILITY

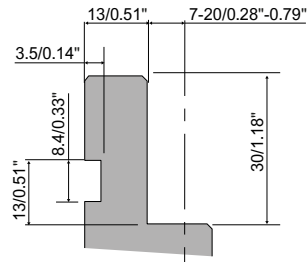

TECHNICAL INFORMATION

Length	150 mm 5.90"
Max.press force	1000 Kn/m
Antifall system	●
Pneumatic version	-
Hydraulic version	-
Manual version	●
Back clamp	○

● = standard ○ = only for DOUBLE FAST CLAMP1

INTERMEDIATES	FAST CLAMP1	DOUBLE FAST CLAMP1
<u>INT100F</u>	●	●
<u>INT120F</u>	●	●
<u>INT100</u>	●	●
<u>INT120</u>	●	●
<u>INT150</u>	●	●
<u>INT120-40</u>	●	●
<u>INT150-40</u>	●	●
<u>INT120HD</u>	●	-
<u>INT150HD</u>	●	-
<u>INT120-40HD</u>	●	-
<u>INT150-40HD</u>	●	-



Request our bending, punching and ironworker, consumables laser, panel bending tools and shear blades catalogues on www.rolleritools.com/download



Find out more about this clamping system by scanning the QR code or clicking on it.
Create your account on www.rolleritools.com

FAST CLAMP3 is a combination of traditional clamps with screws and with a lever. Clamps are made of a more resistant material and undergo several treatments to increase their resistance and to avoid corrosion. Clamps are opened and closed by means of a lever rotating around a central pin. One of the main features of FAST CLAMP3 is the adjustability of the pin. Thanks to this feature, we can always control the clamping force of punches, even in case punch tang is worn out.

FAST CLAMP3 can be mounted on all standard intermediates and thanks to a hardened back plate, the pin doesn't damage the

intermediate as it happens in traditional clamps.

A removable lever extender can be used in order to open and close clamps easier. Such lever extender can be used to open clamps with LC shorter lever mounted on the right edge of the upper beam to avoid collision during box bending.

With KDS (double clamping kit) system you can open and close front and back clamp at the same time by using the central lever.

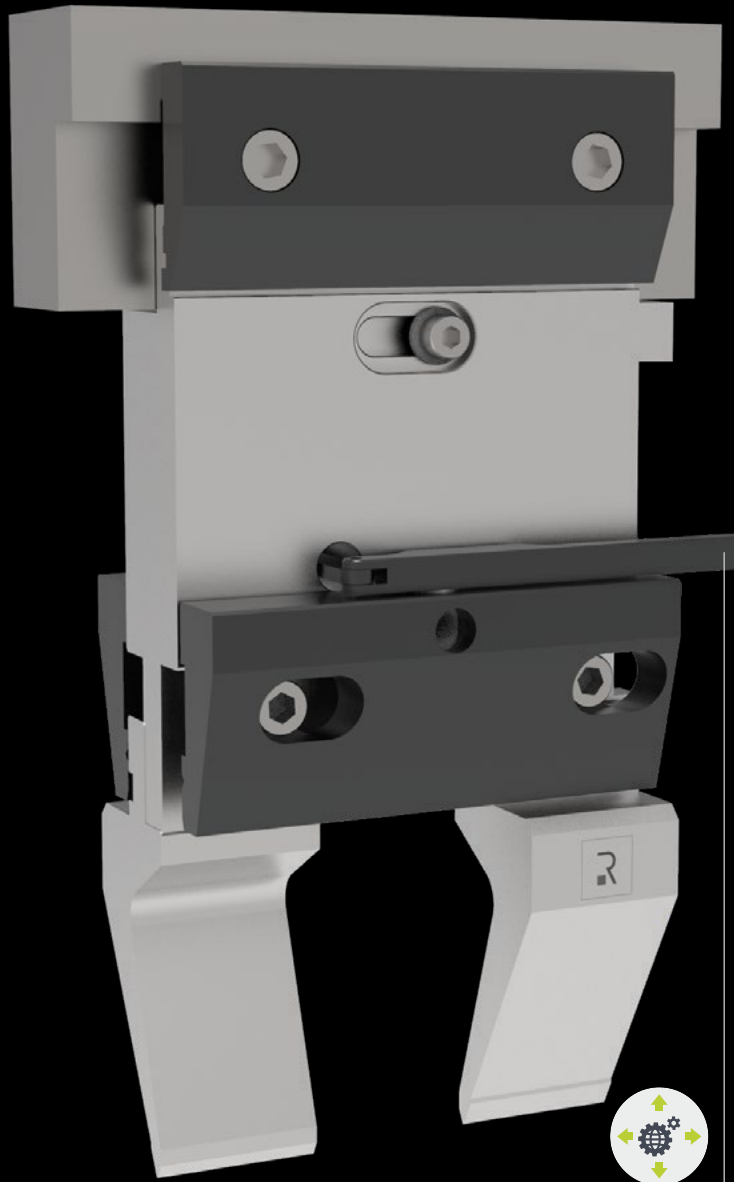

Clamp is equipped with an ergonomic lever to open and close clamp easily



UPPER SYSTEM



FAST CLAMP3 is compatible with all press brakes with Amada-Promecam tang. No tooling modification is required.

DOUBLE CLAMPING



FAST CLAMP3 is available with front clamp only and with double clamps (front and back) - DOUBLE FAST CLAMP3

TOOL CHANGE



Clamp is equipped with an ergonomic and adjustable lever to open and close clamp easily. Thanks to the adjustable pin, the clamping force is always under control.

TOOL ALIGNMENT



Thanks to its curved form and its elasticity, FAST CLAMP3 guarantees punch perfect clamping and alignment, including short segments.

SAFETY



Punches are safely clamped thanks to the clamp antifall nose.

SUPPLY



The system is available in manual version. It's a complete, manual, fast and convenient clamping system.

INSTALLATION



FAST CLAMP3 is designed for a press brake with 70mm 2.76" distance between intermediates.

COMPATIBILITY

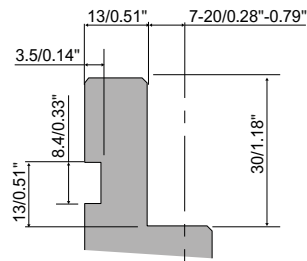

TECHNICAL INFORMATION

Length	150 mm 5.90"
Max.press force	1000 Kn/m
Antifall system	●
Pneumatic version	-
Hydraulic version	-
Manual version	●
Back clamp	○

● = standard ○ = only for DOUBLE FAST CLAMP3

INTERMEDIATES	FAST CLAMP3	DOUBLE FAST CLAMP3
<u>INT100F</u>	●	●
<u>INT120F</u>	●	●
<u>INT100</u>	●	●
<u>INT120</u>	●	●
<u>INT150</u>	●	●
<u>INT120-40</u>	●	●
<u>INT150-40</u>	●	●
<u>INT120HD</u>	●	-
<u>INT150HD</u>	●	-
<u>INT120-40HD</u>	●	-
<u>INT150-40HD</u>	●	-



Request our bending, punching and ironworker, consumables laser, panel bending tools and shear blades catalogues on www.rolleritools.com/download



Find out more about this clamping system by scanning the QR code or clicking on it. Create your account on www.rolleritools.com

EASY CLAMP is the simplest system and it's considered standard all over the world. Intermediates vary a lot ranging from 100mm (3.94") to 150mm (5.90"). They may also have 2 different bending axis: Z1 at 7mm (0.28") and Z2 at 20mm (0.79") from the tang. Each intermediate can be used with manual clamps (with screws) and fast clamps (with lever).

Every clamp type is also available with ground clamping surface or with polyurethane insert to clamp better segmented punches. EASY CLAMP can have fix height with +/- 0.01mm tolerance or it

can be equipped with a crowning wedge. By releasing the central screw and moving it to the left or to the right, crowning wedge is moved and intermediate height adjusted.

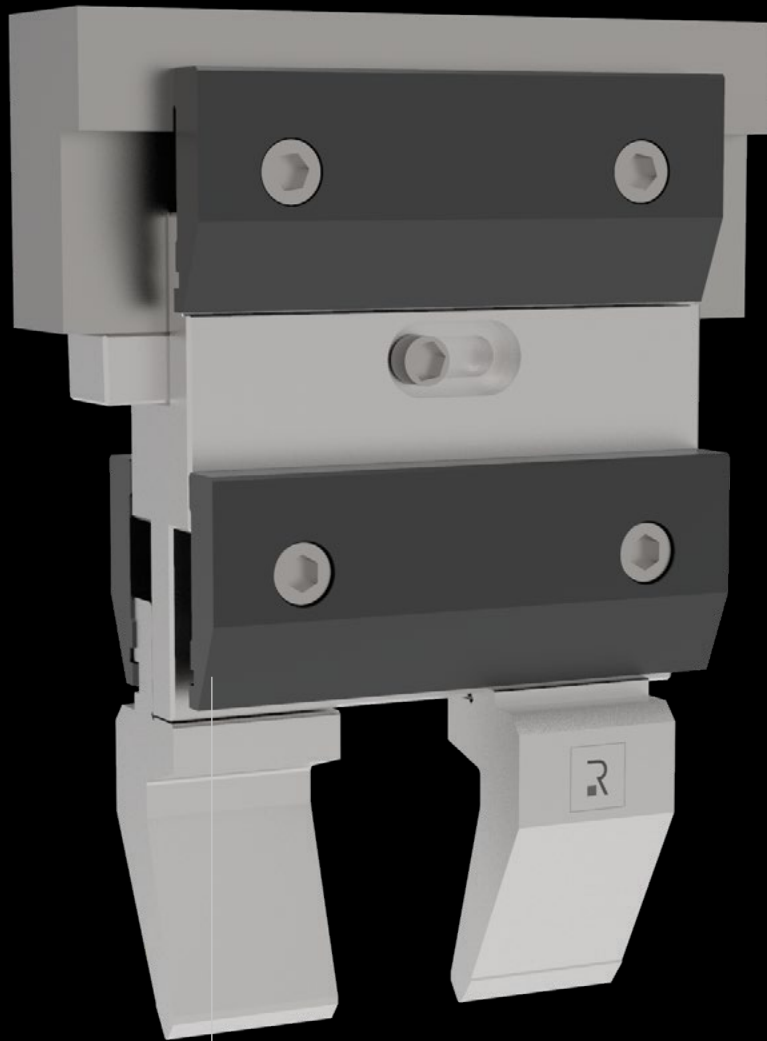

Polyurethane inserts enable better tool clamping, especially segmented tools

UPPER SYSTEM



EASY CLAMP3 is compatible with all press brakes with Amada-Promecam tang. No tooling modification is required.

DOUBLE CLAMPING



EASY CLAMP is available with front clamp only and with double clamps (front and back) - DOUBLE EASY CLAMP. The system offers different front clamps (ST60/ST60R/STG60 - STL60/STL60R/STLG60 - STX60/STX60R/STXG60)

TOOL CHANGE



ST60 clamps are opened and closed with screws and enable horizontal tool change. Back clamp too enables horizontal tool change.

TOOL ALIGNMENT



Punches are aligned manually or by simulating a bending process without sheet metal so that punch presses in the die V opening. Afterwards you can tighten clamp screws.

SAFETY



Screw driven clamps guarantee safe tool clamping even in manual mode. A special optional polyurethane insert clamps better sectioned tools.

SUPPLY



The system is available in manual version. It's a complete, manual, fast and convenient clamping system.

INSTALLATION



EASY CLAMP is designed for a press brake with 50mm 1.97" distance between intermediates. Installation is easy and intuitive. In order to install intermediates with wedges properly, check the press brake user manual to adjust the height to compensate the upper beam deformation.

COMPATIBILITY

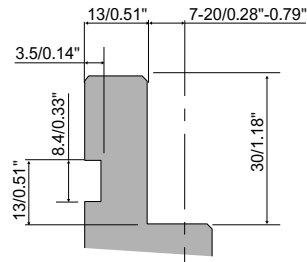

TECHNICAL INFORMATION

Length	150 mm 5.90"
Max.press force	1000 Kn/m
Antifall system	●
Pneumatic version	-
Hydraulic version	-
Manual version	●
Back clamp	○

● = standard ○ = only for DOUBLE EASY CLAMP

INTERMEDIATES	EASY CLAMP	DOUBLE EASY CLAMP
<u>INT100F</u>	●	●
<u>INT120F</u>	●	●
<u>INT100</u>	●	●
<u>INT120</u>	●	●
<u>INT150</u>	●	●
<u>INT120-40</u>	●	●
<u>INT150-40</u>	●	●
<u>INT120HD</u>	●	-
<u>INT150HD</u>	●	-
<u>INT120-40HD</u>	●	-
<u>INT150-40HD</u>	●	-



Request our bending, punching and ironworker, consumables laser, panel bending tools and shear blades catalogues on www.rolleritools.com/download



Find out more about this clamping system by scanning the QR code or clicking on it. Create your account on www.rolleritools.com

UNIVERSAL FAST CLAMP is a combination of traditional clamps with screws and with a lever. Clamps are made of a more resistant material and undergo a several treatments to increase their resistance and to avoid corrosion.

UNIVERSAL FAST CLAMP has been designed to clamp R1 and American style tooling. A special insert with several grooves can be moved to the front or to the back to clamp R1 or American style punches.

Clamps are opened and closed by means of a lever rotating around a central pin. One of the main features of UNIVERSAL FAST CLAMP is the adjustability of the pin. Thanks to this feature, we can always control the clamping force of punches, even in case punch tang is worn out.

UNIVERSAL FAST CLAMP can be mounted on all standard intermediates and thanks to a hardened back plate, the pin doesn't damage the intermediate as it happens in traditional clamps.

A removable lever extender can be used in order to open and close clamps easier. Such lever extender can be used to open clamps with LC shorter lever mounted on the right edge of the upper beam to avoid collision during box bending.

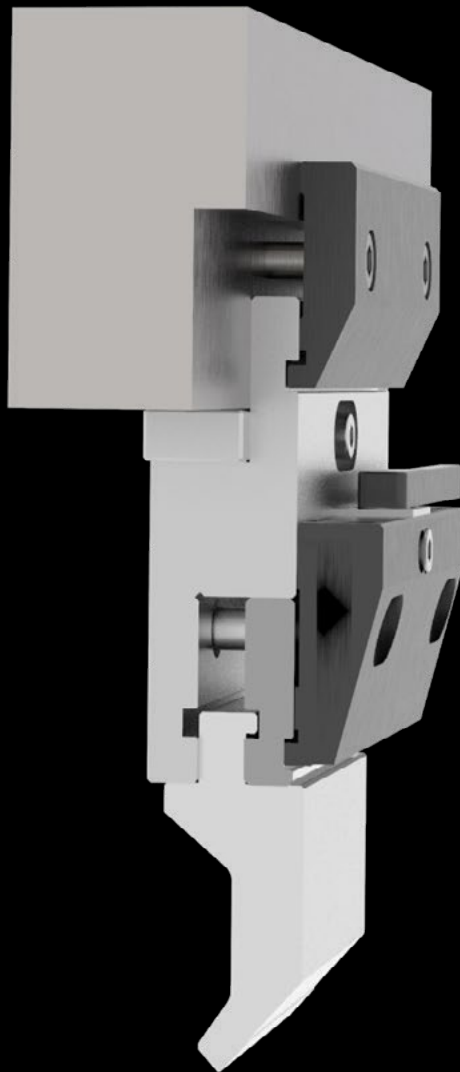

UPPER SYSTEM



UNIVERSAL FAST CLAMP is compatible with all press brakes with American and Amada-Promecam tang. No tooling modification is required.

CLAMP



UNIVERSAL FAST CLAMP is available with front clamp only.

TOOL CHANGE



Clamp is equipped with an ergonomic and adjustable lever to open and close clamp easily. Thanks to the adjustable pin, the clamping force is always under control.

TOOL ALIGNMENT



Thanks to its curved form and its elasticity, UNIVERSAL FAST CLAMP guarantees the perfect clamping and alignment of punches, including short segments.

SAFETY



Punches are safely clamped thanks to the clamp antifall nose.

SUPPLY



The system is available in manual version. It's a complete, manual, fast and convenient clamping system.

INSTALLATION



UNIVERSAL FAST CLAMP is designed for a press brake with 70mm 2.76" distance between intermediates.

COMPATIBILITY

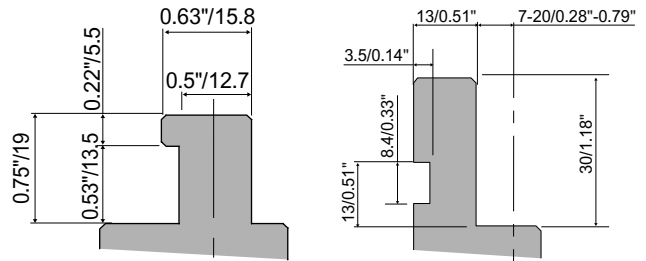

TECHNICAL INFORMATION

Length	150 mm 5.90"
Max.press force	1000 Kn/m
Antifall system	●
Pneumatic version	-
Hydraulic version	-
Manual version	●
Back clamp	-

● = Standard

INTERMEDIATES	UNIVERSAL FAST CLAMP
INT100-A	●
INT100-A American	●
INT120-40-A	●
INT150-A	●
INT120-A	●



Request our bending, punching and ironworker, consumables laser, panel bending tools and shear blades catalogues on www.rolleritools.com/download



Find out more about this clamping system by scanning the QR code or clicking on it. Create your account on www.rolleritools.com

UNIVERSAL EASY CLAMP is the simplest system and it's considered standard for tools with R1 and American tangs.

A special insert with several grooves can be moved to the front or to the back to clamp R1 or American style punches.

Intermediates vary a lot ranging from 3.94" (100mm) to 4.72" (120mm). They may also have 2 different bending axis: Z1 at 0.28" (7mm) and Z2 at 0.79" (20mm) from the tang. Each intermediate can be used with ST60 standard clamp.

UNIVERSAL EASY CLAMP is equipped with a crowning wedge.

By releasing the central screw and moving it to the left or to the right, crowning wedge is moved and intermediate height adjusted.

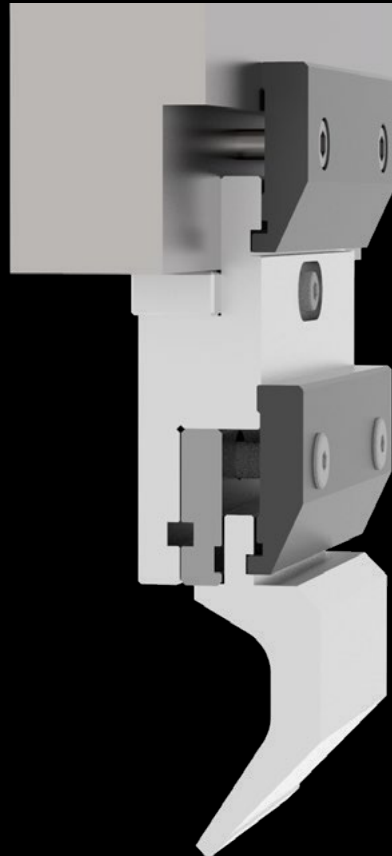

UPPER SYSTEM



UNIVERSAL EASY CLAMP is compatible with all press brakes with American and Amada-Promecam tang. No tooling modification is required.

CLAMP



UNIVERSAL FAST CLAMP is available with front clamp only.

TOOL CHANGE



ST60 clamps are opened and closed with screws and enable horizontal tool change.

TOOL ALIGNMENT



Punches are aligned manually or by simulating a bending process without sheet metal so that punch presses in the die V opening. Afterwards you can tighten clamp screws.

SAFETY



Screw driven clamps guarantee safe tool clamping even in manual mode.
A special optional polyurethane insert clamps better sectioned tools.

SUPPLY



The system is available in manual version.
It's a complete, manual, fast and convenient clamping system.

INSTALLATION



UNIVERSAL EASY CLAMP is designed for a press brake with 1.97" (50mm) distance between intermediates. Installation is easy and intuitive. In order to install intermediates with wedges properly, check the press brake user manual to adjust the height to compensate the upper beam deformation.

COMPATIBILITY

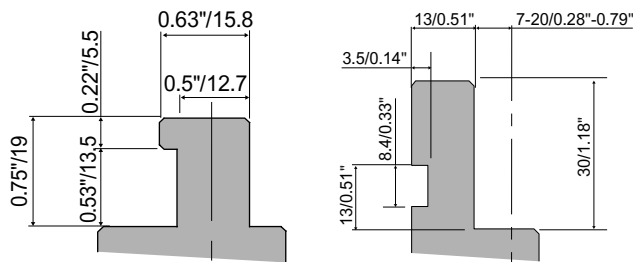

TECHNICAL INFORMATION

Length	150 mm 5.90"
Max.press force	1000 Kn/m
Antifall system	●
Pneumatic version	-
Hydraulic version	-
Manual version	●
Back clamp	-

● = standard

INTERMEDIATES	UNIVERSAL EASY CLAMP
INT100-A	●
INT100-A American	●
INT120-40-A	●
INT150-A	●
INT120-A	●



Request our bending, punching and ironworker, consumables laser, panel bending tools and shear blades catalogues on www.rolleritools.com/download



Find out more about this clamping system by scanning the QR code or clicking on it.
Create your account on www.rolleritools.com

ST50-S is a simple but innovative solution to ease die change onto the press brake table.

ST50-S is considered a retractable clamp, as it can be pushed downwards when screws are released and reaches the same height of the press brake table. With ST50-S you don't have to slide dies sideways and push them until they reach their working position. You can place a die directly onto the press brake table in its working position with 3 advantages: operator's safety, less

exertion, no table or die base damages, which guarantees better precision.



**LOWER SYSTEM**

ST50-S is compatible with all press brakes with Amada-Promecam tang. No tooling modification is required.

**FRONT CLAMP**

ST50-S is mounted on the front side of a press brake.

**TOOL CHANGE**

Dies can be easily changed, as they can be slid frontally without having to lift them.

**TOOL ALIGNMENT**

ST50-S can line up and clamp dies perfectly thanks to 2 front screws.

**SAFETY**

Dies can be safely changed thanks to this retractable die, as operator doesn't have to lift them over clamps. This means operator's safety and better care for tools and press brake table.

**SUPPLY**

The system is available in manual version. It's a complete, manual, fast and convenient clamping system.

**INSTALLATION**

ST50-S is designed for a press brake with 100mm hole pitch. Put the two M10 allen screws of the table into the die slots and slide the clamp following the slot shape without removing the screws.

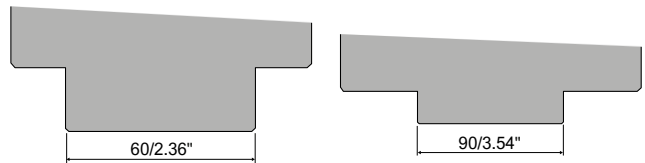
COMPATIBILITY**TECHNICAL INFORMATION**

Material	Fe37: 370-470 N/mm ²
Length	170 mm 6.69"
Max.press force	50 mm 1.97"
Pneumatic version	-
Hydraulic version	-
Manual version	●
Back clamp	-

● = standard

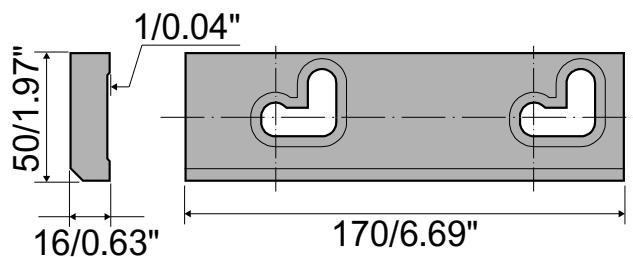

Scan the QRCode or click on it and watch the video to discover more about this system



Find out more about this clamping system by scanning the QR code or clicking on it.

Create your account on www.rolleritools.com

Crowning tables enable mechanical compensation of any press brake deflection. Such deflection is directly proportional to bending length and to the ratio between sheetmetal thickness and die V opening.

Rolleri crowning table is composed of a bar made of special steel opposite to a wedge row.

Each wedge can be individually set to compensate better small working areas.

The bar can be activated manually or automatically thanks to a motoreducer connected to press brake CNC.

Crowning table setup is very simple and fast.

Every table is manufactured according to press brake features in order to improve its activity and integration with a press brake.

Rolleri offers several table versions according to the tang of dies to be clamped. Our tables are supplied with all necessary accessories to be mounted and lined up perfectly with a press brake upper beam.

Die clamping system can be manual, pneumatic or hydraulic.

- Possibility to compensate the whole press brake length or only some areas of it thanks to independent wedges
- Always precise bending angles
- Possibility to clamp R1 dies with 60mm and 90mm base, R2 dies with 13mm tang, R4 and R5 dies.
- Automatic crowning thanks to the connection with press brake CNC or manual crowning with a lever
- Possibility to be installed in new press brakes or in already operating press brakes
- Precise positioning and alignment on press brake table
- Easy and fast use

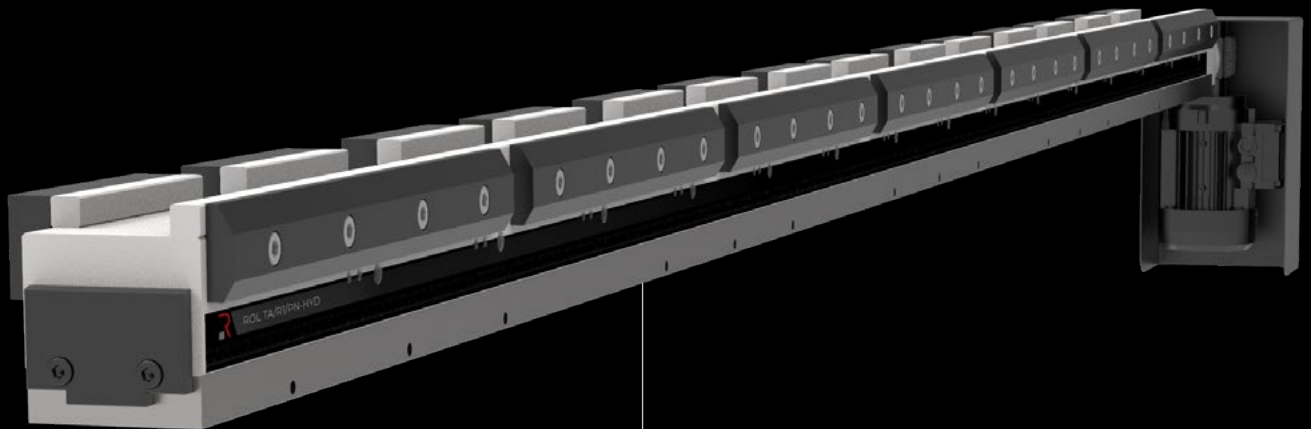

TX



Rolleri adjustment system during installation is very useful to adjust the overall table length.

The subsequent advantage is correct position of the bending axis in relation to backgauges. Thanks to this, precision and repeatability are guaranteed for any profile.



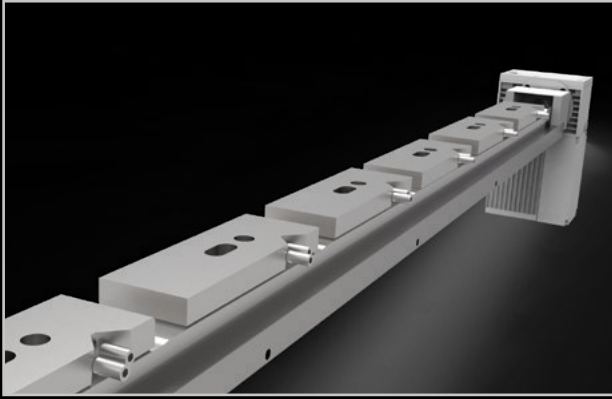

The images on the left show the way a single wedge can be adjusted for local compensation. This system aids the overall crowning given by the central bar.

On the front side of a table there is a screw with a scale to adjust a specific point along the table. The use is simple and efficient and shows in every moment the type of crowning used to bend any sheet metal.

In this way you can also compensate different thickness you can detect in the same sheet.

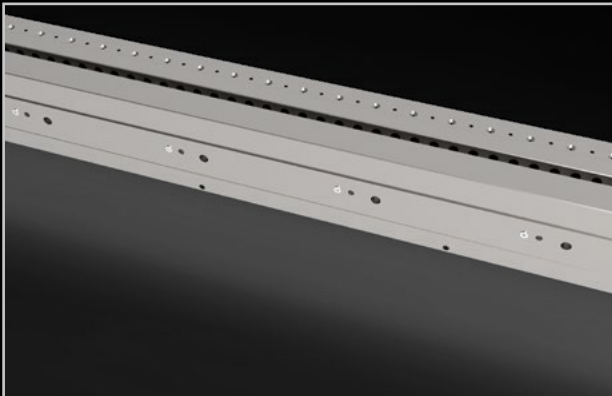

In addition, the images show how the crowning table is secured. Two main features are highlighted: easy installation and simple adjustment of the overall length thanks to reference pins.

Rolleri crowning table is very compact to limit overall dimensions and guarantee high capacity.

OPTION:

- Possibility to have the same hole pitch present on the press brake table
- Possibility to clamp dies with different tang type
- Motor is positioned as standard on the right of operator's side; on request it can be positioned on the left.

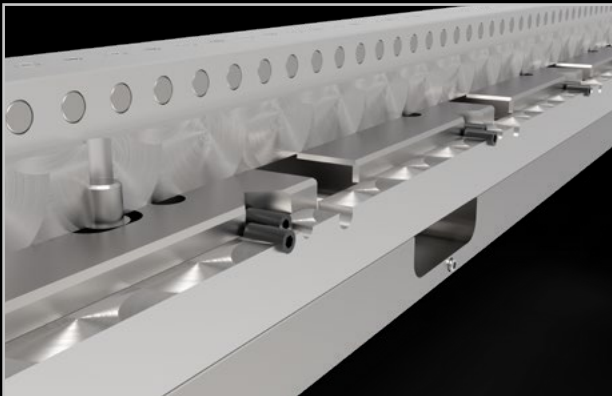

Request our bending, punching and ironworker, consumables laser, panel bending tools and shear blades catalogues on www.rolleritools.com/download



Find out more about this clamping system by scanning the QR code or clicking on it.
Create your account on www.rolleritools.com

ROL TM/R1/MN

For dies	R1
Crowning type	manual
Clamping	manual
Material	C45 hardened and ground
Max.	2000 kN/m

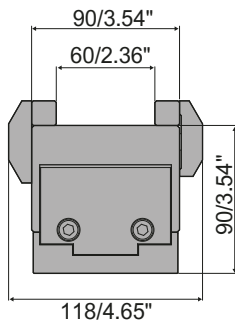
**ROL TM/R1/HYD-PN**

For dies	R1
Crowning type	manual
Clamping	pneumatic or hydraulic
Material	C45 hardened and ground
Max.	2000 kN/m

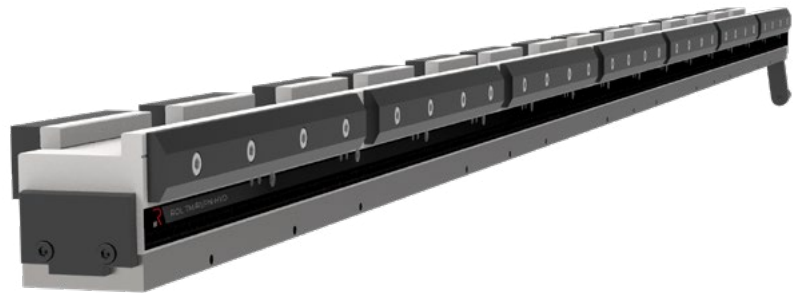
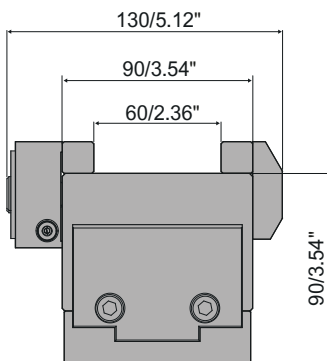

Download or request our bending, punching and ironworker, consumables laser, panel bending tools and shear blades catalogues on www.rolleritools.com/download

- Table can be supplied with the same hole pitch of press brake
- Table can have different die clamping slots
- Possibility to change motor position

ROL TA/R1/MN



For dies	R1
Crowning type	motorized
Clamping	manual
Material	C45 hardened and ground
Max.	2000 kN/m

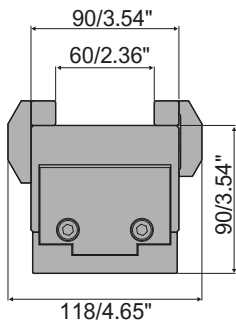

ROL TA/R1/HYD-PN



For dies	R1
Crowning type	motorized
Clamping	pneumatic or hydraulic
Material	C45 hardened and ground
Max.	2000 kN/m

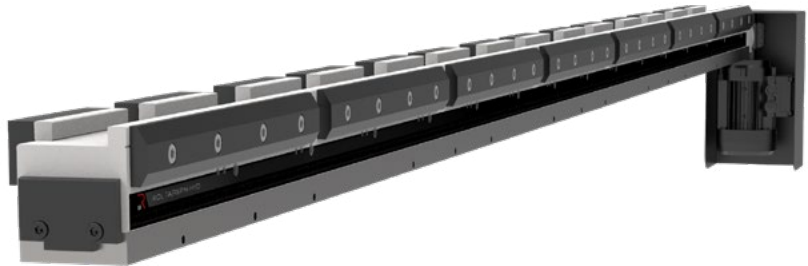
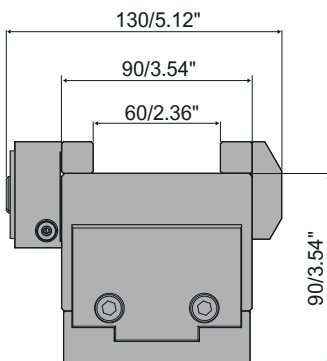

Request our bending, punching and ironworker, consumables laser, panel bending tools and shear blades catalogues on www.rolleritools.com/download



Find out more about this clamping system by scanning the QR code or clicking on it.
Create your account on www.rolleritools.com

ROL TM/R2/MN

For dies	R2-R3-R4-R5
Crowning type	manual
Clamping	manual
Material	C45 hardened and ground
Max.	2000 kN/m

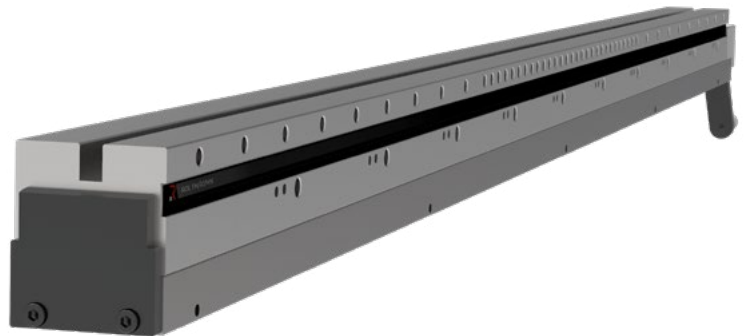
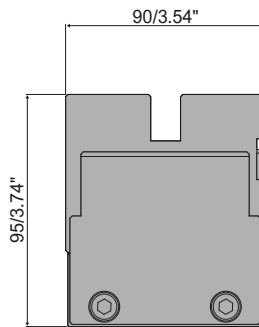

ROL TM/R2/HYD-PN

For dies	R2-R3-R4-R5
Crowning type	manual
Clamping	pneumatic or hydraulic
Material	C45 hardened and ground
Max.	2000 kN/m

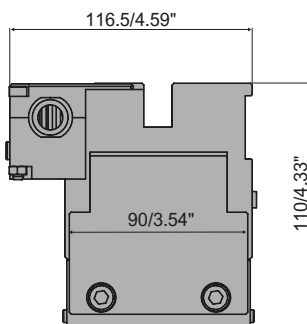

Download or request our bending, punching and ironworker, consumables laser, panel bending tools and shear blades catalogues on www.rolleritools.com/download

- Table can be supplied with the same hole pitch of press brake
- Table can have different die clamping slots
- Possibility to change motor position

ROL TA/R2/MN



For dies	R2-R3-R4-R5
Crowning type	motorized
Clamping	manual
Material	C45 hardened and ground
Max.	2000 kN/m

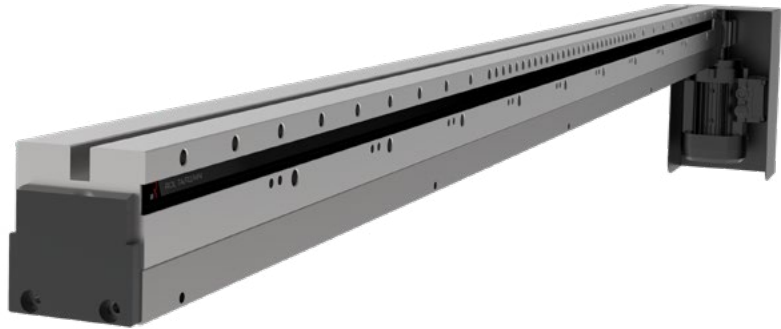
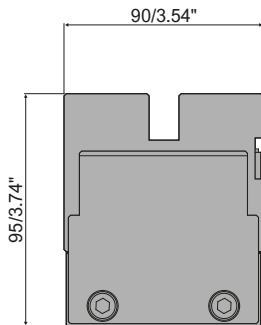

ROL TA/R2/HYD-PN



For dies	R2-R3-R4-R5
Crowning type	motorized
Clamping	pneumatic or hydraulic
Material	C45 hardened and ground
Max.	2000 kN/m

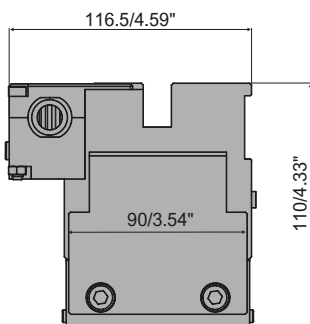

Request our bending, punching and ironworker, consumables laser, panel bending tools and shear blades catalogues on www.rolleritools.com/download



Find out more about this clamping system by scanning the QR code or clicking on it.

ROL TA/R1/HYD-PN-SPE9

For dies	R1
Clamping	pneumatic or hydraulic
Material	C45 hardened and ground
Max.	2000 kN/m
Corsa massima	20 mm 0.79"
Crowning type	manual available ROL TA/R1/MN-SPE9

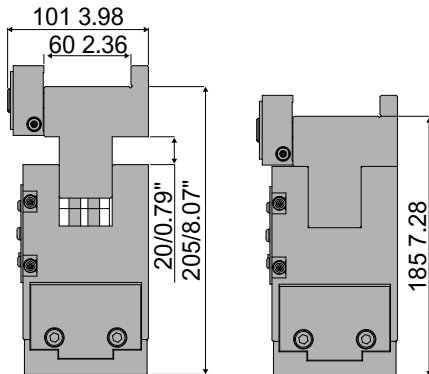
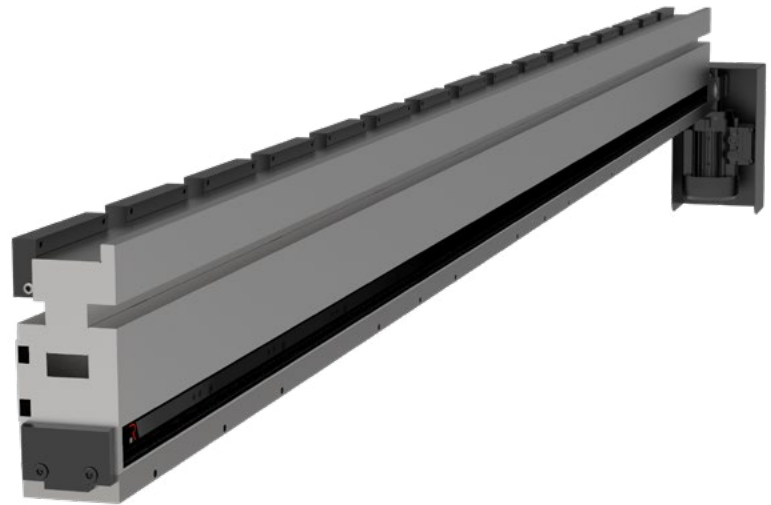

ROL TA/R2/HYD-PN-SPE9

For dies	R2-R3-R4-R5
Clamping	pneumatic or hydraulic
Material	C45 hardened and ground
Max.	2000 kN/m
Corsa massima	20 mm 0.79"
Crowning type	manual available ROL TA/R2/MN-SPE9

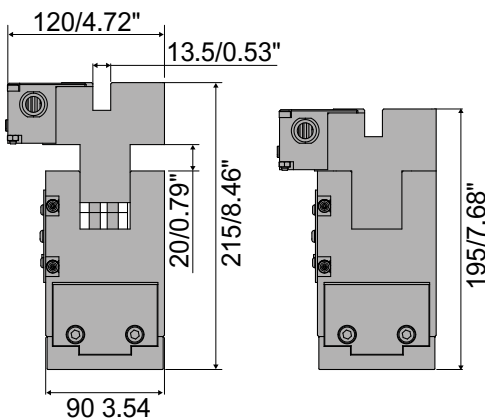

Download or request our bending, punching and ironworker, consumables laser, panel bending tools and shear blades catalogues on www.rolleritools.com/download

- Table can be supplied with the same hole pitch of press brake
- Table can have different die clamping slots
- Possibility to change motor position

PDU MOLT

- Checks air pressure at system inlet and outlet
- Amplifies compressed air for better clamping
- Gives an electric signal to CNC in case of low pressure and activates alarm stop
- Working pressure: 12 bar
- Supplied with pressure multiplier
- Available in TOP version in a protective cabinet

PDU 2 MOLT

- Checks air pressure at system inlet and outlet
- Amplifies compressed air for better clamping
- Gives an electric signal to CNC in case of low pressure and activates alarm stop
- It can control two pneumatic systems
- Supplied with pressure multiplier
- Available in TOP version in a protective cabinet

HPU-E/1

- To be connected to press brake CNC for opening and closing
- Gives an electric signal to CNC in case of low pressure and activates alarm stop
- It works with 220-380V
- Operating pressure: 30/80/160 bar

HPU-E/2

- To be connected to press brake CNC for opening and closing
- Gives an electric signal to CNC in case of low pressure and activates alarm stop
- It works with 220-380V
- Operating pressure: 30/80/160 bar
- It can control two hydraulic systems

HPU-EXL/1

- To be connected to press brake CNC for opening and closing
- Gives an electric signal to CNC in case of low pressure and activates alarm stop
- It works with 220-380V
- Operating pressure: 30/80/160 bar
- With enlarged pump and motor

HPU-EXL/2

- To be connected to press brake CNC for opening and closing
- Gives an electric signal to CNC in case of low pressure and activates alarm stop
- It works with 220-380V
- Operating pressure: 30/80/160 bar
- It can control two hydraulic systems
- With enlarged pump and motor



Download Roller Clamping App.

It contains useful information for all clamping systems, details for the installation and all the user manuals for all those who already have Roller systems or who are interested in integrating these with their own press brake.



Find out more about power units by scanning the QR code or clicking on it.

Create your account on www.rolleritools.com

INTERMEDIATES

Intermediates can be fix or with crowning wedge. For fix intermediates, working height with $\pm 0.01\text{mm}$ tolerance is fundamental, as it eases any lower crowning system. The second type of intermediates is represented by adjustable intermediates thanks to a crowning wedge.

In this way you can adjust any press brake following a fix scheme according to the press brake length. Each intermediate has to be numbered and positioned always in the same place to get perfect crowning and subsequently precise angles.



INT100F

150 mm 5.90" 4 kg

C45: 560-710 N/mm²
1000 kN/m max.

W=100 | H=130 mm
W=3.94 | H=5.12 in

Without crowning wedge

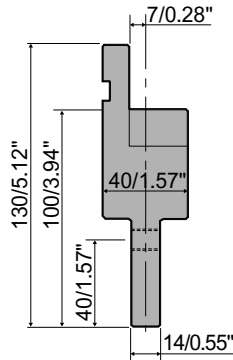

INT100

150 mm 5.90" 3.5 kg

C45: 560-710 N/mm²
1000 kN/m max.

W=100 | H=130 mm
W=3.94 | H=5.12 in

With crowning wedge



INT120F

150 mm 5.90" 4 kg

C45: 560-710 N/mm²
1000 kN/m max.

W=120 | H=150 mm
W=4.72 | H=5.91 in

Without crowning wedge

Intermediates available on request also in L=70 mm.

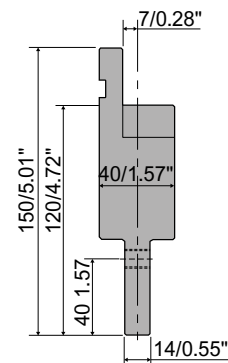

INT120

150 mm 5.90" 3.5 kg

C45: 560-710 N/mm²
1000 kN/m max.

W=120 | H=150 mm
W=4.72 | H=5.91 in

With crowning wedge

Intermediates available on request also in L=70 mm.



INT150

150 mm 5.90" 5.9 kg

C45: 560-710 N/mm²
1000 kN/m max.

W=150 | H=180 mm
W=5.91 | H=7.09 in

Without crowning wedge

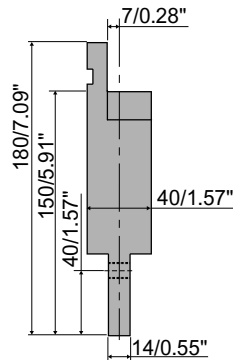

INT120-40

150 mm 5.90" 5.2 kg

C45: 560-710 N/mm²
1000 kN/m max.

W=120 | H=150 mm
W=4.72 | H=5.91 in

With crowning wedge

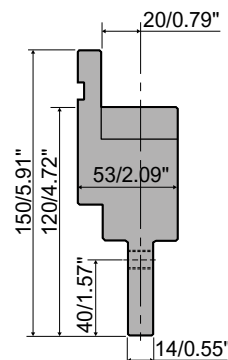

Intermediates can be fix or with crowning wedge. For fix intermediates, working height with +/-0.01mm tolerance is fundamental, as it eases any lower crowning system.

The second type of intermediates is represented by adjustable intermediates thanks to a crowning wedge.

In this way you can adjust any press brake following a fix scheme

according to the press brake length. Each intermediate has to be numbered and positioned always in the same place to get perfect crowning and subsequently precise angles.

INT150-40

150 mm 5.90" 8 kg

C45: 560-710 N/mm²
1000 kN/m max.

W=150 | H=180 mm
W=5.91 | H=7.09 in

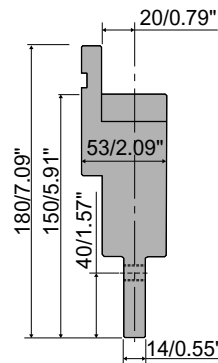

INT120HD

150 mm 5.90" 4.5 kg

42CrMo4
1600 kN/m max.

W=120 | H=150 mm
W=4.72 | H=5.91 in

Heavy duty

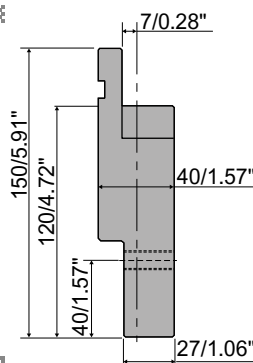

INT150HD

150 mm 5.90" 6.7 kg

42CrMo4
1600 kN/m max.

W=150 | H=180 mm
W=5.91 | H=7.09 in

Heavy Duty

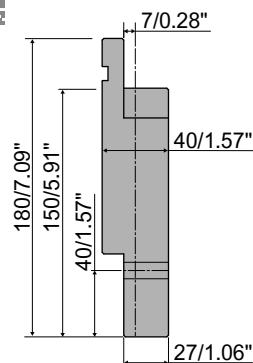

As integration of standard solutions, Rolleri has created Heavy Duty intermediates. Their main feature is their capacity.

In case you need more than 1000 kN/m, you have to choose these intermediates, which are made of different material and with different dimensions to reach 1600 kN/m.

According to the application, you can choose intermediates with

bending axis at 7mm or 20mm from the tang.

All Heavy Duty intermediates are equipped with a crowning wedge.

INT120-40HD

150 mm 5.90" 5.2 kg

42CrMo4
1600 kN/m max.

W=120 | H=150 mm
W=4.72 | H=5.91 in

Heavy Duty

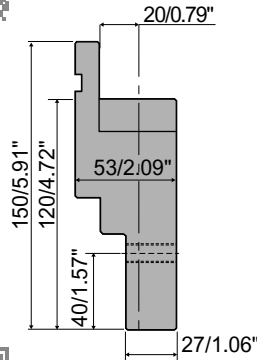

INT150-40HD

150 mm 5.90" 8 kg

42CrMo4
1600 kN/m max.

W=150 | H=180 mm
W=5.91 | H=7.09 in

Heavy Duty

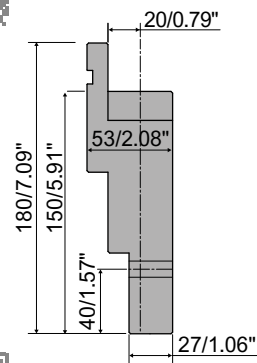

INT100-A

150 mm 5.90" 3.5 kg

C45: 560-710 N/mm²
1000 kN/m max.

W=100 | H=130 mm
W=3.94 | H=5.12 in

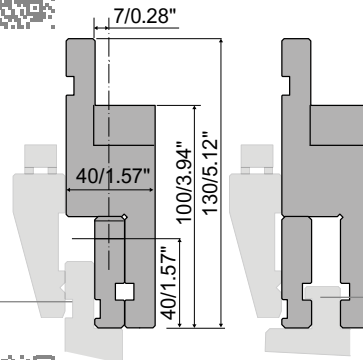

INT120-A

150 mm 5.90" 5.2 kg

C45: 560-710 N/mm²
1000 kN/m max.

W=120 | H=150 mm
W=4.72 | H=5.91 in

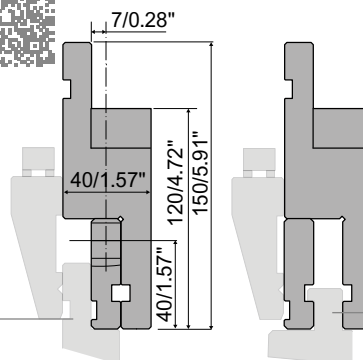

Create your account on www.rolleritools.com
You can use Rolleri website to check the delivery time, request quotes, stay update with the news, check prices and place orders directly.



Find out more about INT100-A e INT120-A by scanning the QR code or clicking on it.

INT120-40-A

150 mm 5.90" 6 kg

C45: 560-710 N/mm²
1000 kN/m max.

W=120 | H=150 mm
W=4.72 | H=5.91 in

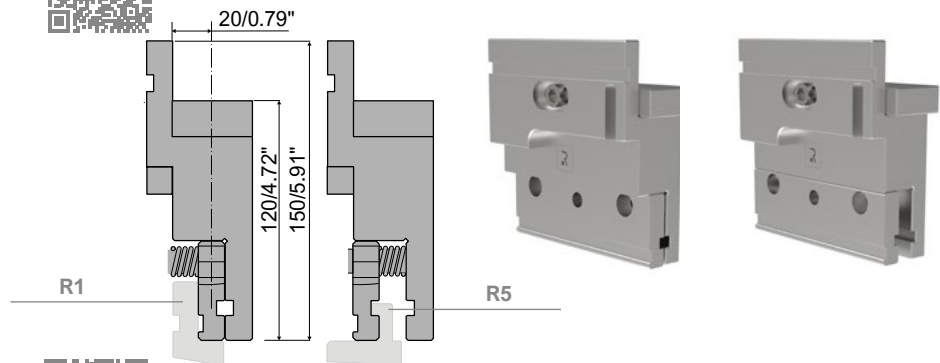

INT100-A AMERICAN

150 mm 5.90" 3.5 kg

x → R1

C45: 560-710 N/mm²
1000 kN/m max.

W=100 | H=119 mm
W=3.94 | H=4.69 in

Tang AM1: INT100-AAM1
Tang AM2: INT100-AAM2
Tang AM3: INT100-AAM3

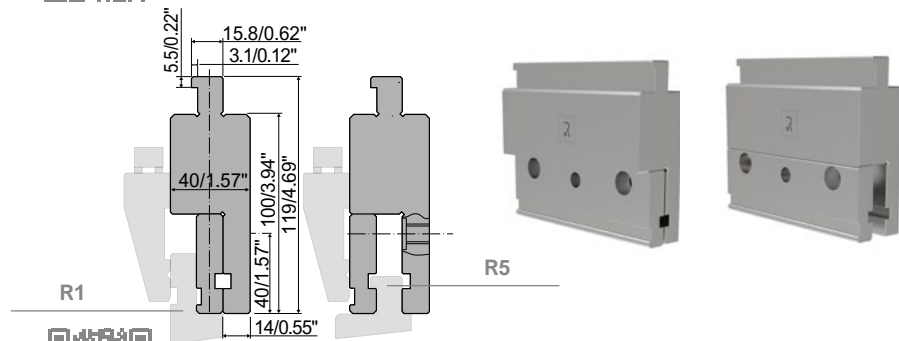

AD4

150 mm 5.90" 1.8 kg

C45: 560-710 N/mm²
1600 kN/m max.

W=60 | H=90 mm
W=2.36 | H=3.54 in

Without crowning wedge

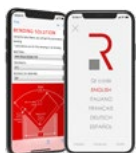
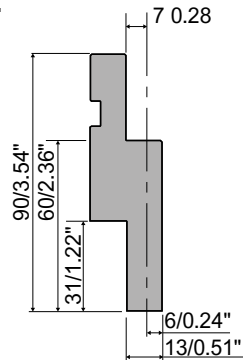

Download Roller Bending App

You will have access to our online store where you can get what you need. You will also get our sheet metal unfolding software for free and our bending rule.



The **Bending handbook** target is to supply practice and useful information to reach quickly the required result. A lot of examples, easy formulas and information which explain the proper attitude towards the bending process.

ST50 / ST50R / STG50

STL50	150 mm	5.90"	0.7 kg
ST50R	150 mm	5.90"	0.5 kg
STG50	150 mm	5.90"	0.7 kg

Fe37: 370-470 N/mm²

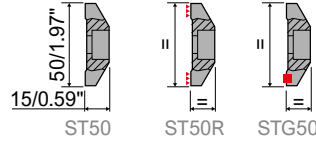
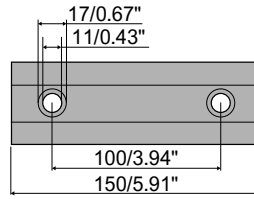

ST60 / ST60R / STG60

ST60	150 mm	5.90"	0.8 kg
ST60R	150 mm	5.90"	0.8 kg
STG60	150 mm	5.90"	0.8 kg

Fe37: 370-470 N/mm²

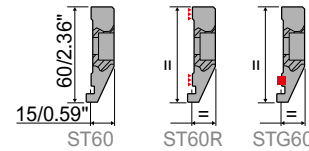
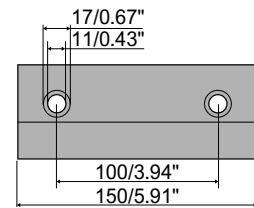

STL60 / STL60R / STLG60

STL60	150 mm	5.90"	1.0 kg
STL60R	150 mm	5.90"	0.8 kg
STLG60	150 mm	5.90"	1.0 kg

Fe37: 370-470 N/mm²

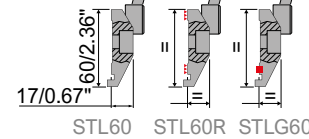
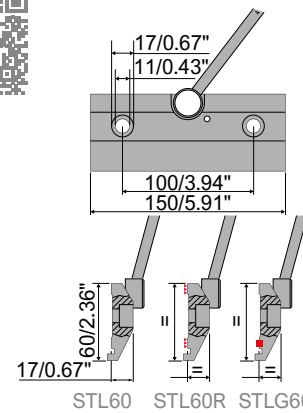

STX60 / STX60R / STXG60

STX60	150 mm	5.90"	0.85 kg
STX60R	150 mm	5.90"	0.5 kg
STXG60	150 mm	5.90"	1.0 kg

Fe37: 370-470 N/mm²

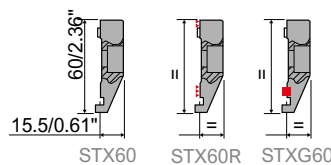
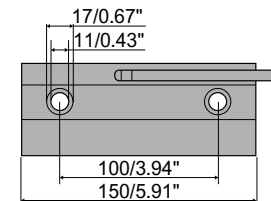

Clamps are a fundamental component for the proper clamping of upper tooling. Every intermediate needs a clamp, which can be manual like ST50 or ST60 or with a lever like STL60 or with a retractable lever like STX60. All clamps with number 60 in their code have an antifall nose. When clamp screws are released, punch hangs and only when the operator slides it sideways, it can be removed

safely. A further evolution of these clamping systems is represented by a polyurethane insert in clamps with lever to clamp segmented tools better.

KDS

150 mm 5.90" 0.5 kg

Fe37: 370-470 N/mm²

Rear clamp

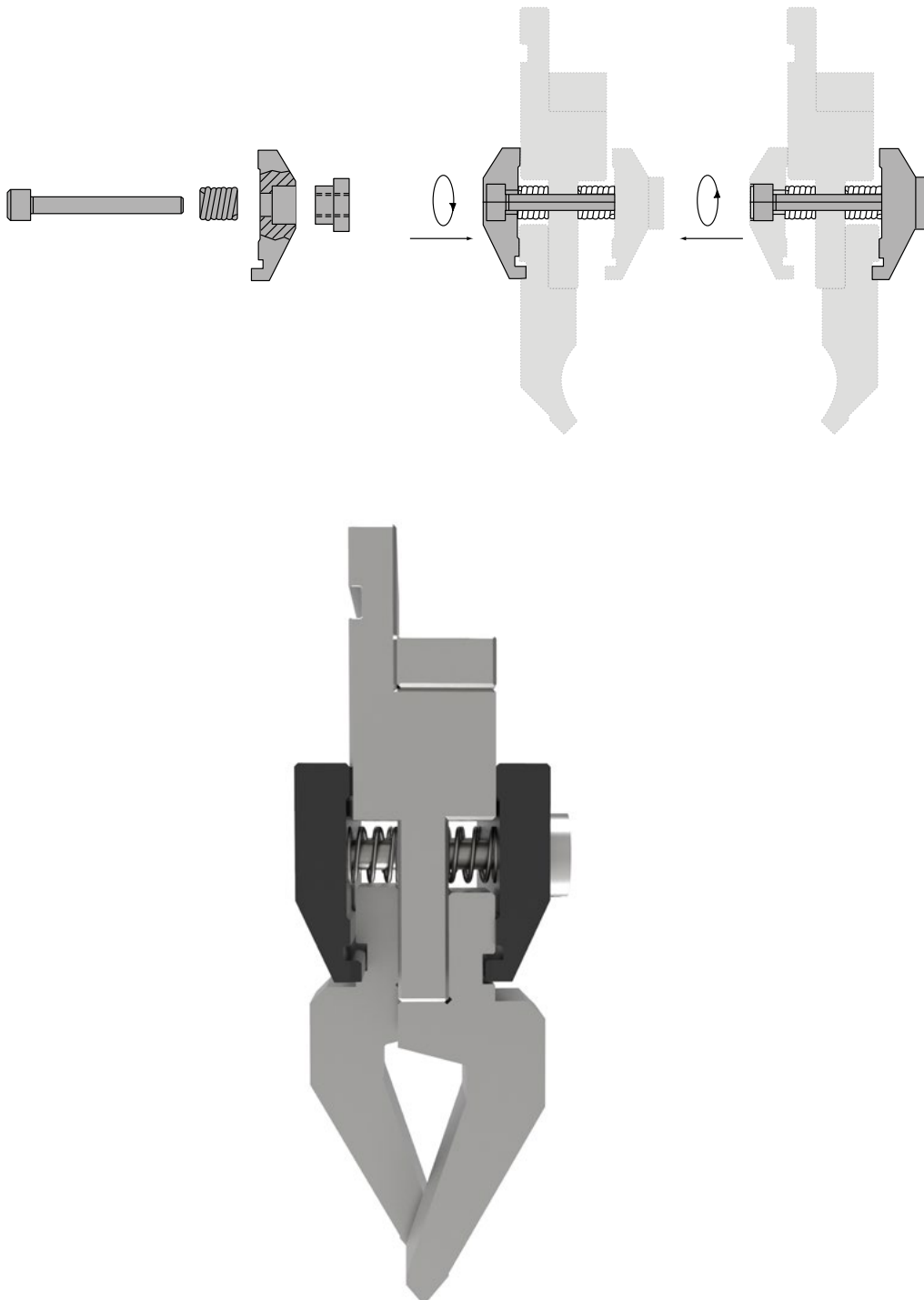

The acronym KDS means in Italian "kit for double clamping" and this is a very useful solution for whom needs to mount punches on the opposite side as normal. The system is designed so that the two front screws can clamp front punch by tightening them, but by releasing them, back punch is tightened.

Thanks to this design, the operator doesn't have to go to the press brake backside to clamp back clamps.

ADAPTERS

Adapters are designed to equip a press brake with a wider range of tooling regardless of the original tool clamping system of a press brake.

There are upper adapters to mount punches properly and lower adapters to clamp dies.

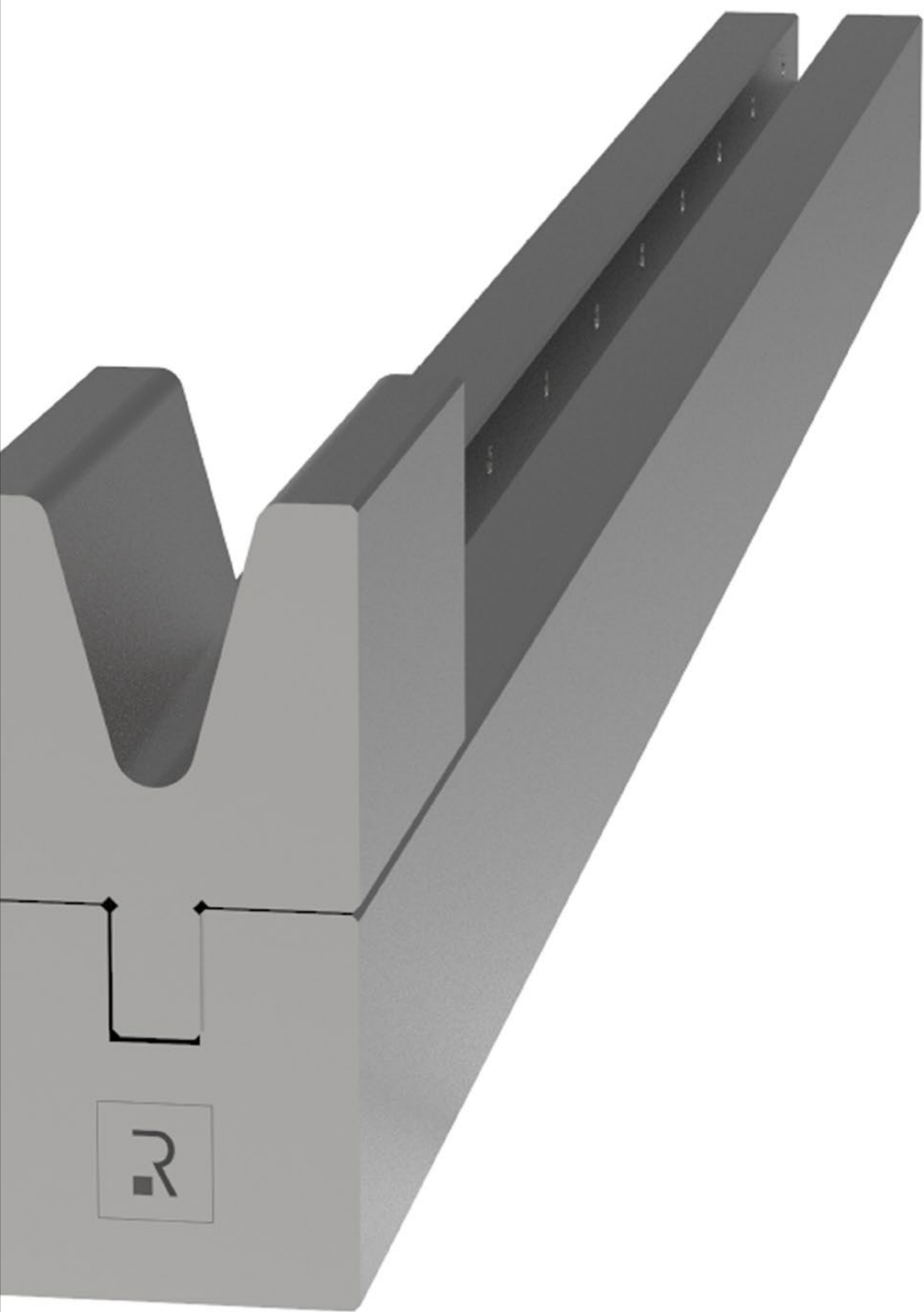



There are two categories: upper adapters for punches and lower adapters for dies. Upper adapters have very precise dimensions and limited height. They are studied to be mounted directly to press brake upper beam and when mounted, they can host punches with a different tang than the original one. Such solution is very interesting when you have to retrofit a press brake: in a press brake with a special tang you can mount all standard tools in the catalogue.

Thanks to this operation, time and costs are reduced.

Adapter precision needs to have max +/-0.01mm tolerance, so that bending axis is precise and guaranteed. In this way you can get precise profiles, as distance between backgauges and die V center is also precise.

As far as dimensions is concerned, we have limited height not to lose too much daylight. Length is mostly 150mm and they need a clamp like ST60, STL60 and STX60 (do not forget the possibility to mount a more efficient system like FAST CLAMP3).

In addition to the adapters explained, we can also offer AW adapters. This is another solution to mount standard R1 type tools in a press brake with a different tang. They consist in small adapters as big as press brake tang and as long as the punch they have to be mounted with. They can be supplied in segmented version as well. Some holes

are drilled and countersunk in punch tang, whereas some threaded holes are made in AW adapter so that they can be screwed together and become a single body.

In press brake CNC the total height of punch and adapter has to be set either manually or imported automatically from our DXF drawing. This system offers the possibility to use a wide range of standard R1 type punches and avoid using special tooling.

INT80-100

835 mm 32.87" 25 kg
415 mm 16.34" 12.5 kg

C45: 560-710 N/mm²
1000 kN/m max.

W = 80 - 100 mm
W = 3.15 - 3.94 in

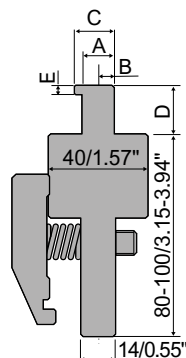

INT67-79

835 mm 32.87" 20.5 kg
415 mm 16.34" 10.0 kg

C45: 560-710 N/mm²
1000 kN/m max.

W = 67 - 79 mm
W = 2.64 - 3.11 in

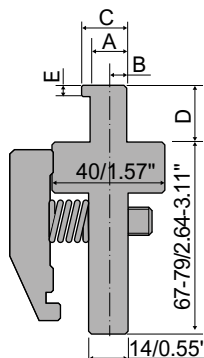

Adapters are designed to equip a press brake with a wider range of tooling regardless of the original tool clamping system of a press brake.

There are upper adapters to mount punches properly and lower adapters to clamp dies.



Request our bending, punching and ironworker, consumables laser, panel bending tools and shear blades catalogues on www.rolleritools.com/download



INT100-N NEWTON

150 mm 5.90" 5.2 kg

C45: 560-710 N/mm²
1000 kN/m max.

W=100 | H=130 mm
W=3.94 | H=5.12 in

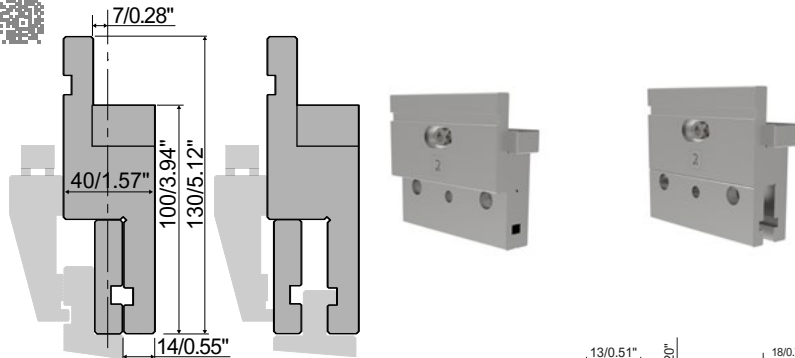

AD1

- AD1-A 150 mm 5.90" 3.1 kg
- AD1-B 150 mm 5.90" 3.1 kg
- AD1-C 150 mm 5.90" 3.1 kg
- AD1-D 150 mm 5.90" 3.1 kg

R4 A, B, C, D → R1
C45: 560-710 N/mm²
1000 kN/m max.

W=100 mm
W=3.94 in

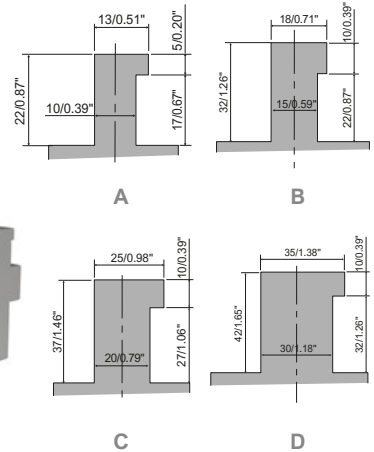
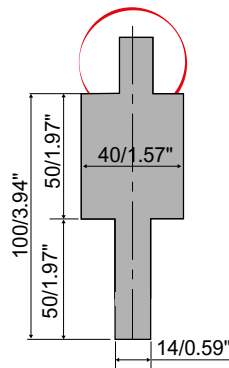

AD3

150 mm 5.90" 3.3 kg

R3 S → R1
C45: 560-710 N/mm²
1000 kN/m max.

W=68 | H=113 mm
W=2.68 | H=4.45 in

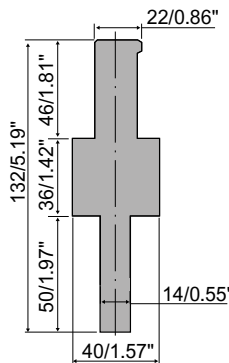

AD10

150 mm 5.90" 3.4 kg

R3 RFA → R1
C45: 560-710 N/mm²
1000 kN/m max.

W=110 | H=140 mm
W=4.33 | H=5.51 in

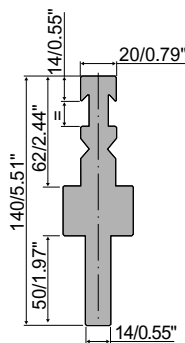

Find out more about INT100-N Newton by scanning the QR code or clicking on it.



Create your account on www.rolleritools.com
You can use Rolleri website to check the delivery time, request quotes, stay update with the news, check prices and place orders directly.

AD11

150 mm 5.90" 3 kg

R2 → R1
 C45: 560-710 N/mm²
 1000 kN/m max.

W=83 | H=120 mm
 W=3.27 | H=4.72

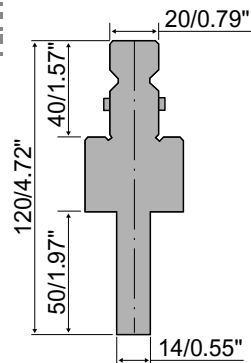

AD12

150 mm 5.90" 3 kg

R8 → R1
 C45: 560-710 N/mm²
 1000 kN/m max.

W=82 | H=120 mm
 W= 3.23 | H=4.72 in

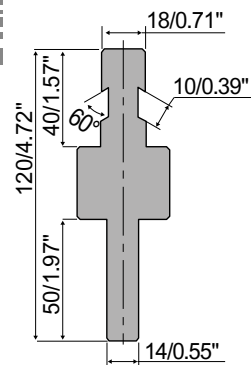

AD13

150 mm 5.90" 3 kg

RX type EHT → R1
 C45: 560-710 N/mm²
 1000 kN/m max.

W=77 | H=140 mm
 W=3.03 | H=5.51 in

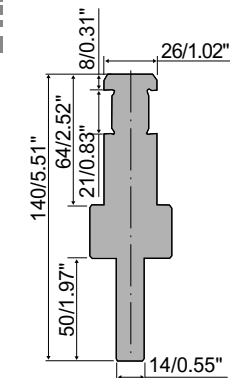

AD14

150 mm 5.90" 3.2 kg

R9 → R1
 C45: 560-710 N/mm²
 1000 kN/m max.

W=82 | H=120 mm
 W= 3.23 | H=4.72 in

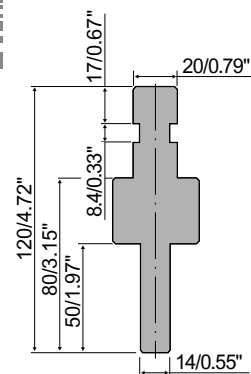

Adapters main feature is getting the bending axis from upper beam and transferring it to punch and then to sheet metal.

Thanks to this system, a press brake with R2 New Standard tang can become a press brake with R1 Promecam tang or the other way around.

Thanks to adapters the need of special tools is considerably reduced.

AD15

150 mm 5.90" 3 kg

R10 → R1

C45: 560-710 N/mm²
1000 kN/m max.

W=100 | H=130 mm
W=3.94 | H=5.12 in

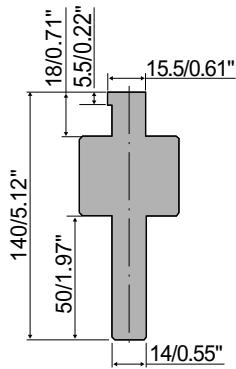

AD16

150 mm 5.90" 4 kg

R5 → R1

C45: 560-710 N/mm²
1000 kN/m max.

W=80 | H=99 mm
W=3.15 | H=3.90 in

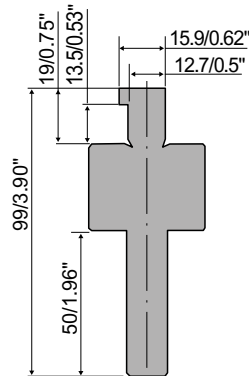

AD19-A

150 mm 5.90" 6 kg

R1 → R4

C45: 560-710 N/mm²
1000 kN/m max.

W=90 | H=120 mm
W=3.54 | H=4.72 in

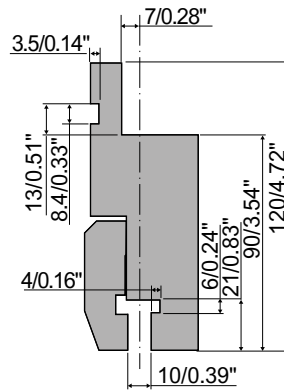

AD20

150 mm 5.90" 4 kg

R1 → R2

C45: 560-710 N/mm²
1000 kN/m max.

W=67 | H=97 mm
W=2.64 | H=3.82 in

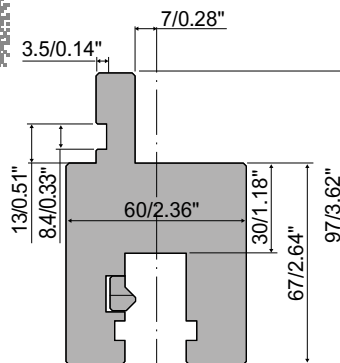

Create your account on www.rolleritools.com
You can use Rolleri website to check the delivery time, request quotes, stay update with the news, check prices and place orders directly.



Download or request bending catalogue tools type American, Ajjal Axial, Colgar, Colly, EHT, Gasparini, Hämmerle-Bystronic, Ursviken, and Weinbrenner on www.rolleritools.com/download

AD20 LVD

AD20 LVD-A	150 mm	5.90"	3.6 kg
AD20 LVD-B	150 mm	5.90"	3.6 kg
AD20 LVD-C	150 mm	5.90"	3.6 kg
AD20 LVD-D	150 mm	5.90"	3.6 kg

R4 A,B,C,D → R1
 C45: 560-710 N/mm²
 1000 kN/m max.

W=68 mm | 2.68 in

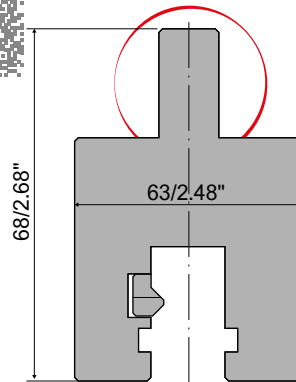

AD21

150 mm	5.90"	7 kg
--------	-------	------

R2 → R2
 42CrMo4
 1500 kN/m max.

W=100 | H=135.8 mm
 W= 3.94 | H=5.35 in

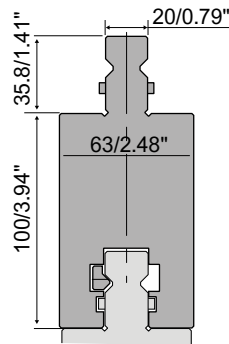

AD22

150 mm	5.90"	3.4 kg
--------	-------	--------

R3 R → R1
 C45: 560-710 N/mm²
 1000 kN/m max.

W=86 | H=132 mm
 W= 3.38 | H=5.19 in

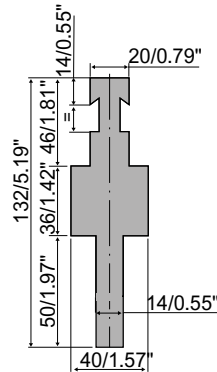

AD23

150 mm	5.90"	5.0 kg
--------	-------	--------

RX Weinbrenner → R1
 C45: 560-710 N/mm²
 1000 kN/m max.

W=119 | H=161 mm
 W= 4.68 | H=6.34 in

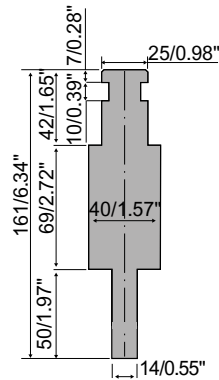

Download Roller Bending App

You will have access to our online store where you can get what you need. You will also get our sheet metal unfolding software for free and our bending rule.



The Bending handbook target is to supply practice and useful information to reach quickly the required result. A lot of examples, easy formulas and information which explain the proper attitude towards the bending process.

AD28

150 mm 5.90" 5 kg

RX EHT → R2

C45: 560-710 N/mm²
1000 kN/m max.

W=65 | H=127 mm
W= 2.56 | H=5.0 in

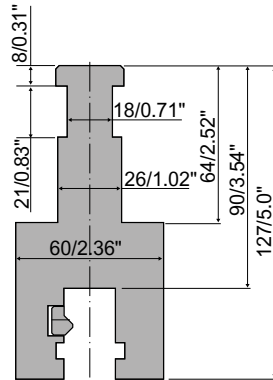

AD29

150 mm 5.90" 4.5 kg

RX Weinbrenner → R2

C45: 560-710 N/mm²
1000 kN/m max.

W=67 | H=107 mm
W= 2.64 | H=4.21 in

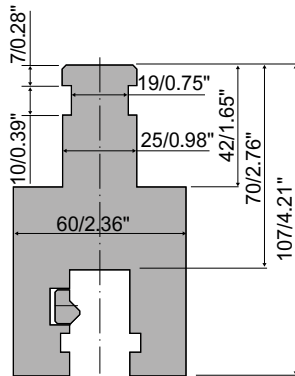

ADX

150 mm 5.90" 3.5 kg

x → R1

C45: 560-710 N/mm²
1000 kN/m max.

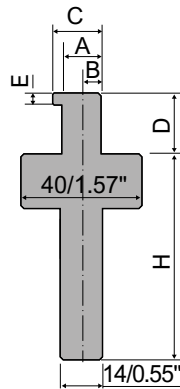

ADX2

150 mm 5.90" 2.4 kg

x → R2

C45: 560-710 N/mm²

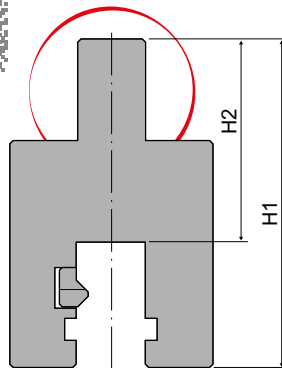

Request our bending, punching and ironworker, consumables laser, panel bending tools and shear blades catalogues on www.rolleritools.com/download



Create your account on www.rolleritools.com
You can use Rolleri website to check the delivery time, request quotes, stay update with the news, check prices and place orders directly.

AW1-A

835 mm	32.87"	3 kg
415 mm	16.34"	1.5 kg
805 mm	31.69"	6.7 kg F



R4 A → R1
 C45: 560-710 N/mm²
 1000 kN/m max.

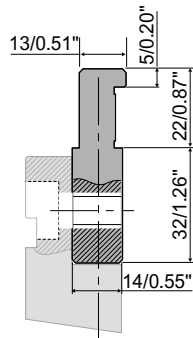

AW1-B

835 mm	32.87"	3 kg
415 mm	16.34"	1.5 kg
805 mm	31.69"	3 kg F



R4 B → R1
 C45: 560-710 N/mm²
 1000 kN/m max.

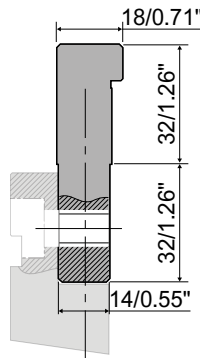

AW1-C

835 mm	32.87"	9.7 kg
415 mm	16.34"	4.8 kg
805 mm	31.69"	9.4 kg F



R4 C → R1
 C45: 560-710 N/mm²
 1000 kN/m max.

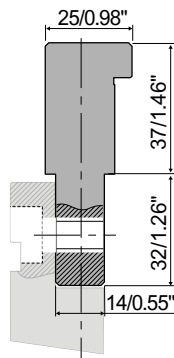

AW1-D

835 mm	32.87"	11.5 kg
415 mm	16.34"	5.7 kg
805 mm	31.69"	11.1 kg F



R4 D → R1
 C45: 560-710 N/mm²
 1000 kN/m max.

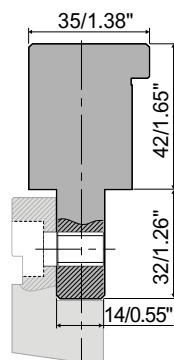

805 mm - 31.69"

mm: <100-370-10-15-20-40-50-100-100>

in: <3.94-14.56-0.39-0.59-0.78-1.57-1.97-3.94-3.94>



Find out more about bolted adapters by scanning the QR code or clicking on it.

AW3

835 mm	32.87"	3 kg	
415 mm	16.34"	1.5 kg	
805 mm	31.69"	3 kg	F

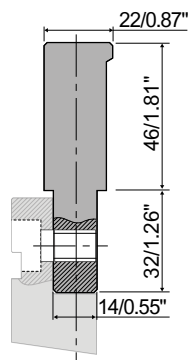

R3 S → R1
 C45: 560-710 N/mm²
 1000 kN/m max.

AW10

835 mm	32.87"	3 kg	
415 mm	16.34"	1.5 kg	
805 mm	31.69"	3 kg	F

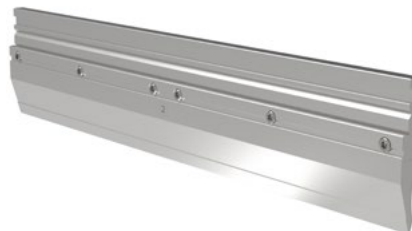
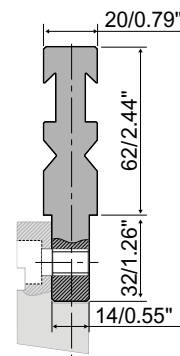

R3 RFA → R1
 C45: 560-710 N/mm²
 1000 kN/m max.

AW11

835 mm	32.87"	8.4 kg	
415 mm	16.34"	4.2 kg	
805 mm	31.69"	8.4 kg	F

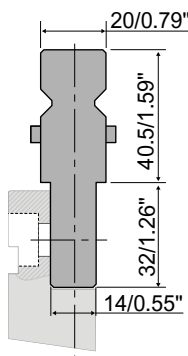

R2 → R1
 C45: 560-710 N/mm²
 1000 kN/m max.

AW12

835 mm	32.87"	7 kg	
415 mm	16.34"	3.5 kg	
805 mm	31.69"	6.7 kg	F

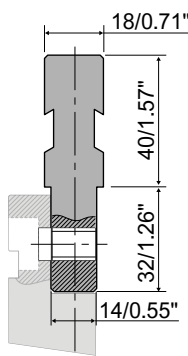

R8 → R1
 C45: 560-710 N/mm²
 1000 kN/m max.

Download Rolleri Bending App

You will have access to our online store where you can get what you need. You will also get our sheet metal unfolding software for free and our bending rule.



The **Bending handbook** target is to supply practice and useful information to reach quickly the required result. A lot of examples, easy formulas and information which explain the proper attitude towards the bending process.



AW13

835 mm	32.87"	12.6 kg
415 mm	16.34"	6.3 kg
805 mm	31.69"	12.1 kg F

RX EHT → R1
 C45: 560-710 N/mm²
 1000 kN/m max.

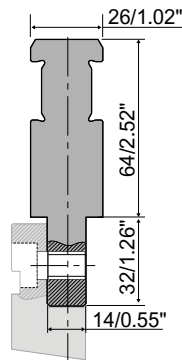

AW14

835 mm	32.87"	8 kg
415 mm	16.34"	4 kg
805 mm	31.69"	7.7 kg F

R9 → R1
 C45: 560-710 N/mm²
 1000 kN/m max.

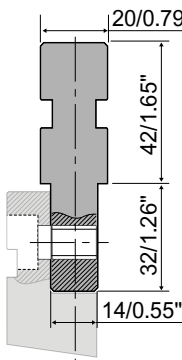

AW15

835 mm	32.87"	3 kg
415 mm	16.34"	1.5 kg
805 mm	31.69"	3 kg F

R10 → R1
 C45: 560-710 N/mm²
 1000 kN/m max.

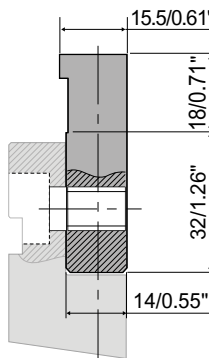

AWC16

835 mm	32.87"	5 kg
415 mm	16.34"	2.5 kg
805 mm	31.69"	4.8 kg F

R7 → R1
 C45: 560-710 N/mm²
 1000 kN/m max.

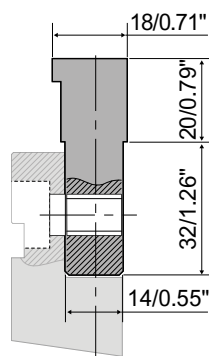

805 mm - 31.69"

mm: <100-370-10-15-20-40-50-100-100>

in: <3.94-14.56-0.39-0.59-0.78-1.57-1.97-3.94-3.94>



Download Roller Bending App

You will have access to our online store where you can get what you need. You will also get our sheet metal unfolding software for free and our bending rule.



AWC13.5



835 mm	32.87"	4.8 kg	
415 mm	16.34"	2.4 kg	
805 mm	31.69"	4.6 kg	F

R7 → R1

C45: 560-710 N/mm²
1000 kN/m max.

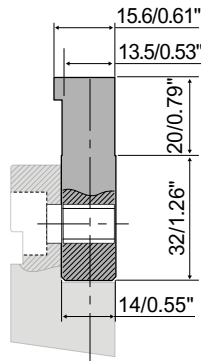

AWX



835 mm	32.87"	3 kg	
415 mm	16.34"	1.5 kg	
805 mm	31.69"	3 kg	F

x → R1

C45: 560-710 N/mm²
1000 kN/m max.

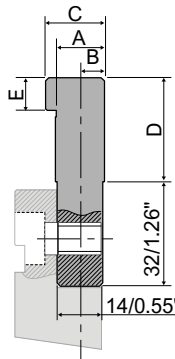

INT35



835 mm	32.87"	4 kg	
415 mm	16.34"	2.5 kg	
805 mm	31.69"	3.9 kg	F

C45: 560-710 N/mm²
1000 kN/m max.

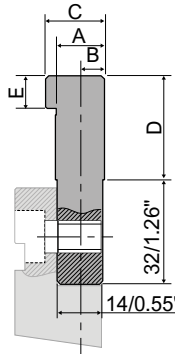

INT35-A



835 mm	32.87"	5 kg	
415 mm	16.34"	2.5 kg	
805 mm	31.69"	4.8 kg	F

C45: 560-710 N/mm²
1000 kN/m max.

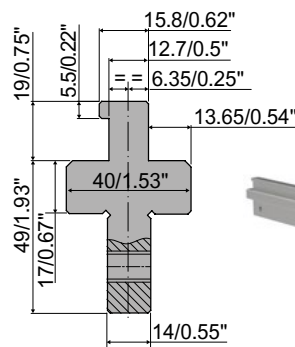

AW4

835 mm	32.87"	5 kg	
415 mm	16.34"	2.5 kg	
805 mm	31.69"	4.8 kg	F

C45: 560-710 N/mm²
1000 kN/m max.

Ground

NEW



Request our bending, punching and ironworker, consumables laser, panel bending tools and shear blades catalogues on www.rolleritools.com/download



Create your account on www.rolleritools.com
You can use Rolleri website to check the delivery time, request quotes, stay update with the news, check prices and place orders directly.

A lower adapter changes the original die slot of a press brake table into a different one.

In the first images you can see die holders. Die holders standardize R1 dies clamping as they can clamp dies with 60mm 2.36" or 90mm 3.53" base. Die holders are positioned directly onto the press brake table, centered and fixed by threaded bars and they are ready to work. In this way every die placed into a die holder will perfectly match with punch.

Standard die holders are max. 4100mm 161.42" long but we can manufacture special die holders up to 6000mm in one single length. For longer die holders you can use standard die holders C1050-R, C1050-RS and C1050-90, which are 1050mm 41.34" long. These die holders can be connected to each other by means of feather keys and they are fixed to the table by threaded bars.

Dies are clamped in a die holder by locking pins on the operator's side.

With the same construction we can offer TC 2000/S up to TC 4000/S (from 2100mm to 4100mm long) to clamp R2 and R3 dies.

For different applications we can offer adapters to clamp standard dies in our catalogue in press brake tables with a different tang. They are 1000mm 39.37" and 835mm 32.87" long and their short /C versions are respectively 500mm 19.68" and 415mm 16.34" long. One of the most common example is AD5 and AD6 which enable R2 dies to be mounted in a press brake with R1 slot.

Thanks to this solution you can bend medium thick sheet metal with tight bends and counterbends like a joggle in 2 hits and a downward side up to 150mm 5.90" long. Dies are clamped in a die holder by locking pins on the operator's side.

Some operators may need the opposite solution. In this case we can offer AD7 to be mounted in a press brake with R2 type die slot and can mount R1 type dies using ST50 clamps.

For the last two examples you can always have to set the press brake CNC considering the total height consisting in die height + adapter height.

Rolleri can always supply a DXF drawing of adapter and die holder mounted together with very precise overall dimensions.

Lower adapters too are manufactured with +/-0.01mm tolerance. This is a fundamental requisite to guarantee maximum precision so that the theoretical machine bending axis is confirmed. This means that all parameters regarding X axis in all press brake programs don't need to be modified.



The **Bending handbook** target is to supply practice and useful information to reach quickly the required result. A lot of examples, easy formulas and information which explain the proper attitude towards the bending process.



Create your account on www.rolleritools.com
You can use Rolleri website to check the delivery time, request quotes, stay update with the news, check prices and place orders directly.

C2000/S-C4000/S

C2000/S	2100 mm	82.68"	27.0 kg
C2500/S	2600 mm	102.36"	34.0 kg
C3000/S	3100 mm	122.05"	40.0 kg
C4000/S	4100 mm	161.42"	53.0 kg

C45: 560-710 N/mm²
1000 kN/m max.

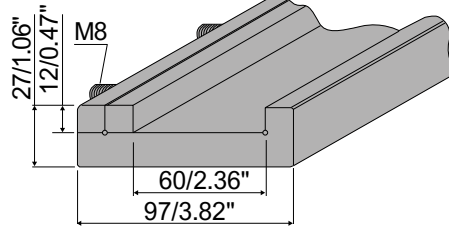

C1050/RS

C1050/RS	1050 mm	41.34"	15.0 kg
C1050/RS/C	520 mm	20.47"	7.5 kg

C45: 560-710 N/mm²
1000 kN/m max.

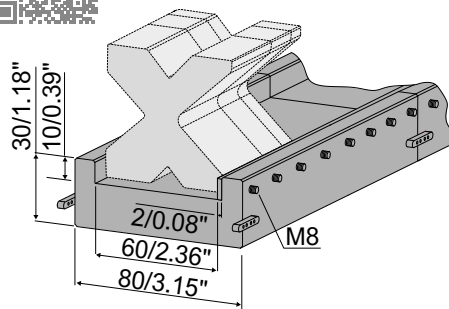

CTS60

835 mm	32.87"	29.0 kg
415 mm	16.34"	14.5 kg

C45: 560-710 N/mm²
1000 kN/m max.

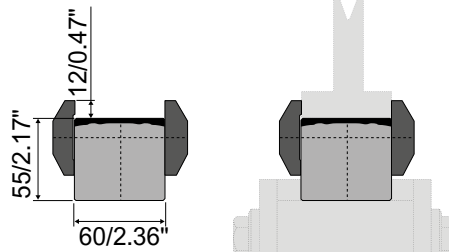

C1050/R

C1050/R	1050 mm	41.34"	15.0 kg
C1050/R/C	520 mm	20.47"	7.5 kg

C45: 560-710 N/mm²
1000 kN/m max.



Request our bending, punching and ironworker, consumables laser, panel bending tools and shear blades catalogues on www.rolleritools.com/download



Download Roller Bending App

You will have access to our online store where you can get what you need. You will also get our sheet metal unfolding software for free and our bending rule.

C1050-90

C1050-90	1050 mm	41.34"	27.2 kg
C1050-90/C	520 mm	20.47"	13.5 kg

C45: 560-710 N/mm²
1000 kN/m max.

H=35 | 1.38

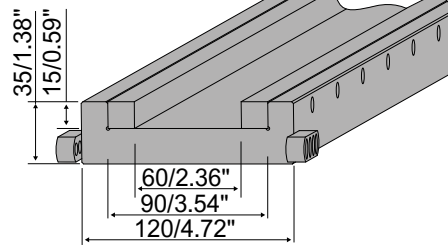

TC2000/S - TC4000/S

TC2000/S	2100 mm	82.68"	30.0 kg
TC2500/S	2600 mm	102.36"	37.0 kg
TC3000/S	3100 mm	122.05"	44.0 kg
TC4000/S	4100 mm	161.42"	59.0 kg

C45: 560-710 N/mm²
1000 kN/m max.

H=35 | 1.38

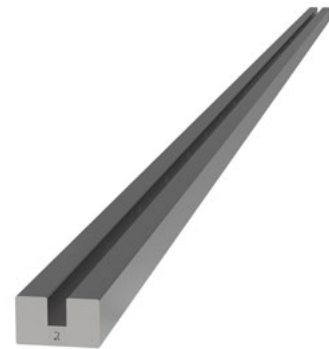
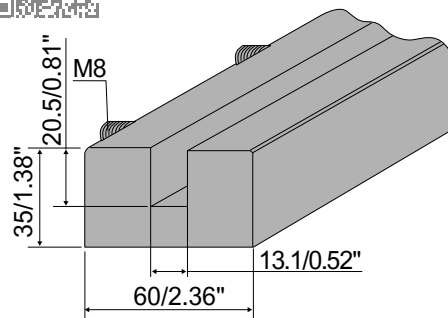

AD5

1000 mm	39.87"	26.1 kg
500 mm	16.68"	13 kg

R1 → R2 R3
C45: 560-710 N/mm²
1000 kN/m max.

H=60 | 2.36

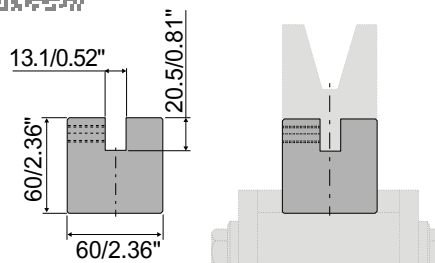

AD6

1000 mm	39.87"	12 kg
500 mm	16.68"	6 kg

R1 → R2 R3
C45: 560-710 N/mm²
1000 kN/m max.

H=30 | 1.18

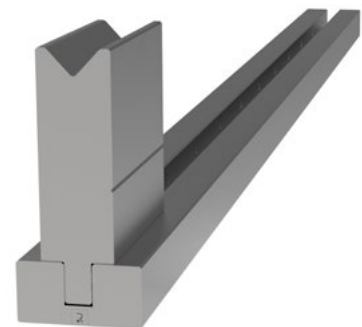
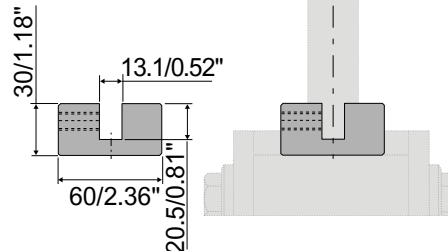

Download Roller Bending App

You will have access to our online store where you can get what you need. You will also get our sheet metal unfolding software for free and our bending rule.



Request our bending, punching and ironworker, consumables laser, panel bending tools and shear blades catalogues on www.rolleritools.com/download

AD7

835 mm 32.87" 25 kg
415 mm 16.34" 8.5 kg

R2 R3 → R1

C45: 560-710 N/mm²
1000 kN/m max.

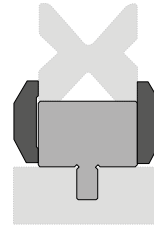
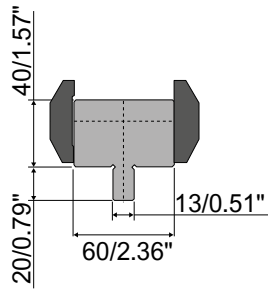

AD8-12.7

1000 mm 39.87" 12 kg
500 mm 16.68" 6 kg

R4 → R2 R3

C45: 560-710 N/mm²
1000 kN/m max.

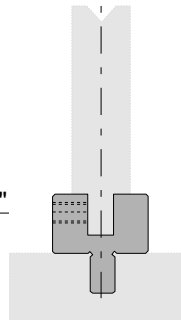
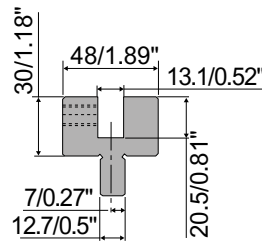

AD9-12.7

835 mm 32.87" 17 kg
415 mm 16.34" 8.5 kg

R4 → R1

C45: 560-710 N/mm²
1000 kN/m max.

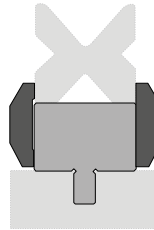
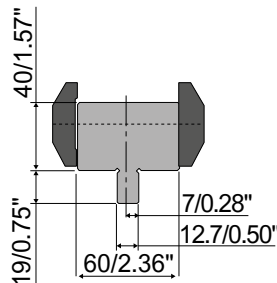

AD17

835 mm 32.87" 18 kg
415 mm 16.34" 18 kg

R5 → R1

C45: 560-710 N/mm²
1000 kN/m max.

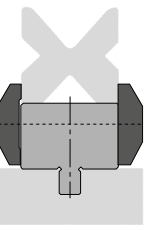
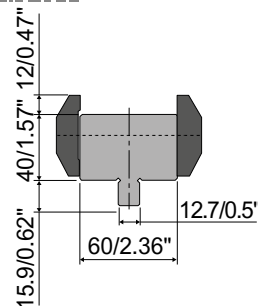

The **Bending handbook** target is to supply practice and useful information to reach quickly the required result. A lot of examples, easy formulas and information which explain the proper attitude towards the bending process.



Create your account on www.rolleritools.com
You can use Rolleri website to check the delivery time, request quotes, stay update with the news, check prices and place orders directly.

AD18

835 mm 32.87" 18 kg
415 mm 16.34" 9 kg

RX EHT → R2 R3
C45: 560-710 N/mm²
1000 kN/m max.

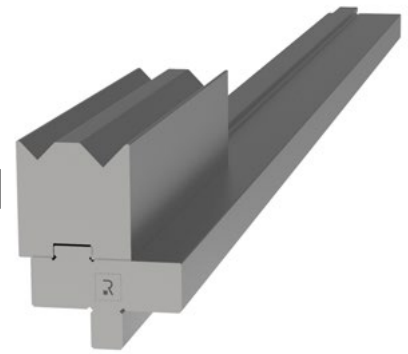
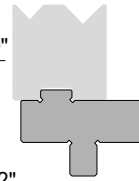
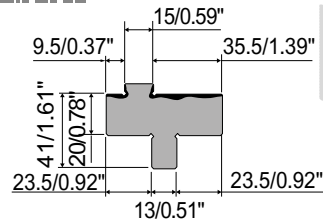

AD24

835 mm 32.87" 30 kg
415 mm 16.34" 14.2 kg

RX EHT → R1
C45: 560-710 N/mm²
1000 kN/m max.

H=72 mm | 2.83 in

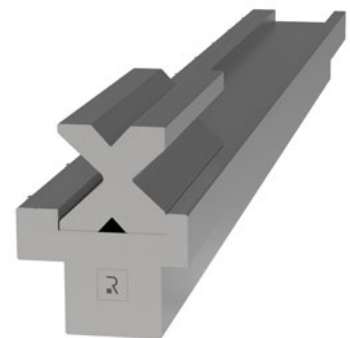
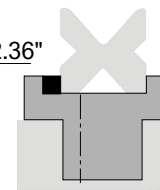
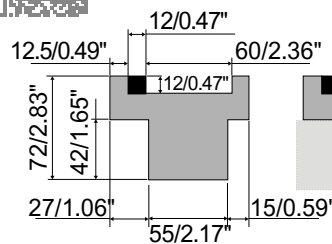

AD25

500 mm 19.68" 7.5 kg

RX Weinbrenner → R2 R3
C45: 560-710 N/mm²
1000 kN/m max.

H=40 mm | 1.57 in

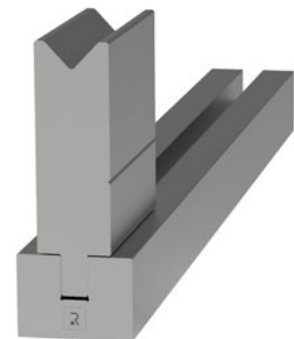
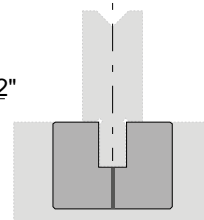
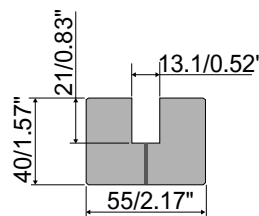

AD26

835 mm 32.87" 23 kg
415 mm 16.34" 11.4 kg

RX Weinbrenner → R1
C45: 560-710 N/mm²
1000 kN/m max.

H=72 mm | 2.83 in

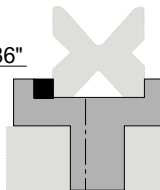
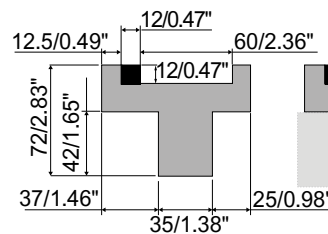

The **Bending handbook** target is to supply practice and useful information to reach quickly the required result. A lot of examples, easy formulas and information which explain the proper attitude towards the bending process.



Request our bending, punching and ironworker, consumables laser, panel bending tools and shear blades catalogues on www.rolleritools.com/download

AD27

500 mm 16.68" 4.5 kg

RX EHT → R2 R3
C45: 560-710 N/mm²
1000 kN/m max.

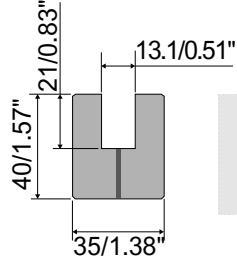

Example of Application

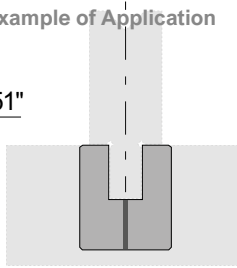

Download Roller Bending App

You will have access to our online store where you can get what you need. You will also get our sheet metal unfolding software for free and our bending rule.



Create your account on www.rolleritools.com

You can use Roller website to check the delivery time, request quotes, stay update with the news, check prices and place orders directly.

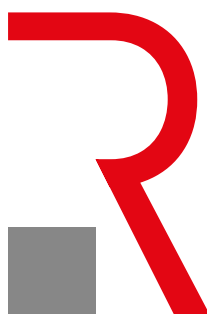

English edition 1.0 | 2020

Rolleri S.p.A.

Via Artigiani · Loc. Cabina · 29020

Vigolzone (PC) · Italy

Tel. +39 0523 870905

Fax +39 0523 879030

www.rolleritools.com

sales@rolleri.it

in

linkedin

f

facebook



instagram



twitter

**You
Tube**

youtube



vimeo